



VACUUM PACKING MACHINE SE-416 230/50-60/1

Tabletop model. 16 m³/h. 420 mm



1140636



SALES DESCRIPTION

420 mm sealing bar.
16 m³/h Busch vacuum pump.
Vacuum controlled by sensor.

- ✓ Powered by Busch.
- ✓ Vacuum controlled by sensor.
- ✓ Vacuum PLUS.
- ✓ Digital keyboard.
- ✓ Control panel equipped with display indicating the exact vacuum percentage.
- ✓ "Pause" button to marinate food.
- ✓ Safe liquid packing thanks to sensor control.
- ✓ Double seal.
- ✓ Cordless sealing bar.
- ✓ Bag-sealing programme.
- ✓ Pulse-controlled decompression.
- ✓ Vac-Norm ready with Automatic decompression.
- ✓ Stainless steel body and chamber. Deep-drawn chamber.
- ✓ Damped transparent lid of highly durable polycarbonate.
- ✓ Dry-oil programme for drying the pump.
- ✓ Working hours counter for oil changes.
- ✓ Safety system with protection against vacuum failure.

INCLUDES

- ✓ Sensor controls
- ✓ Up to 10 seconds of extra vacuum pull
- ✓ Soft air function
- ✓ Dry oil cycle
- ✓ BUSCH pump
- ✓ NSF approved
- ✓ Clear methacrylate lid
- ✓ Filling plate

OPTIONAL

- Vacuum packing bags
- External vacuum kit for Vac-Norm, containers and accessories
- Bag cutting kit
- Support for liquid packaging
- Additional filling plates

ACCESSORIES

- Bag cutting kits
- Filling plates
- Liquid insert plates
- Vac-norm external vacuum kits
- Vac-norm containers
- Smooth bags for vacuum packing
- Trolley for vacuum packing machines

SPECIFICATIONS

Pump capacity: 16 m³/h
 Pump capacity (60 Hz): 19 m³/h
 Bar length: 420 mm
 Total loading: 550 W
 Vacuum pressure (maximum): 2 mbar
 Electrical supply: 230 V / 50-60 Hz / 1 ~ (4.1 A)
 Plug: EU (SCHUKO 2P+G)

Internal dimensions

- ✓ Width: 430 mm
- ✓ Depth: 415 mm
- ✓ Height: 180 mm

External dimensions (WxDxH)

- ✓ Depth: 529 mm
- ✓ Height: 448 mm (230V) / mm (120V)
- ✓ Width: 484 mm
- ✓ Depth: 529 mm
- ✓ Height: 448 mm

Net weight: 50.8 Kg

Noise level (1m.): -- dB(A)
 Background noise: 32 dB(A)

Crated dimensions

600 x 600 x 610 mm
 Gross weight: 59.2 Kg

FOOD PRESERVATION AND SOUS-VIDE
VACUUM PACKING MACHINES · SENSOR LINE

product sheet
updated 07/11/2022



SAMMIC, S.L.
 Basarte, 1 - 20720 Azkoitia
 www.sammic.com



VACUUM PACKING MACHINE SE-416 230/50-60/1

Tabletop model. 16 m³/h. 420 mm



1140636

FOOD PRESERVATION AND SOUS-VIDE
VACUUM PACKING MACHINES · SENSOR LINE

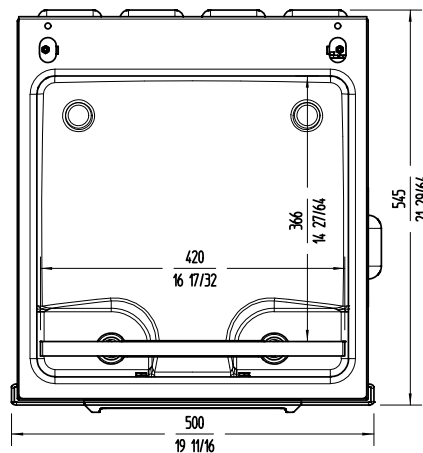
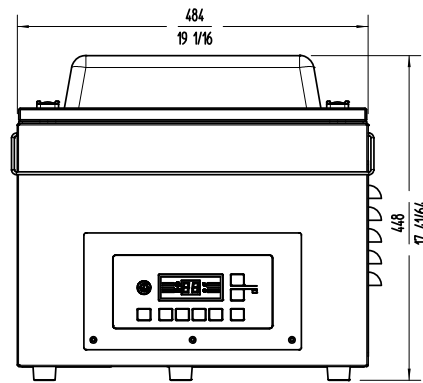
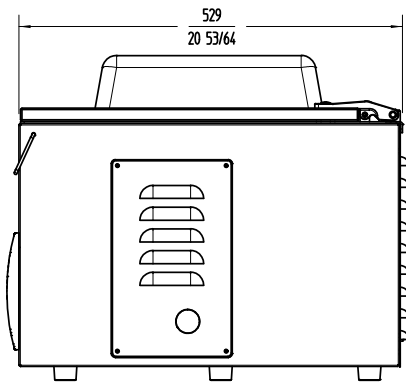

www.sammic.co.uk

Food Service Equipment Manufacturer

Unit 2, Trevanth Road
Troon Industrial Park
LE4 9LS - Leicester

uksales@sammic.com
Tel.: +44 0116 246 1900



Project	Date
Item	Qty
Approved	

product sheet
updated 07/11/2022