

retigo®

PERFECTION IN COOKING AND MORE...

Retigo Orange Vision Plus

USER'S MANUAL



 **READ THIS MANUAL BEFORE USE**

DESCRIPTION OF THE MOST COMMON SCREENS

A MAIN SCREEN

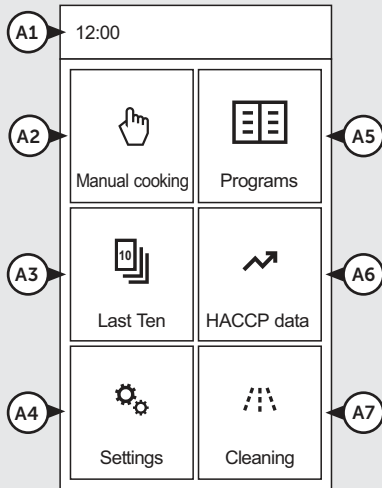

- A1 Current time
- A2 Manual cooking setup
- A3 Selecting previously used programs / baking or cooking methods
- A4 User and service settings
- A5 Selection from saved programs
- A6 Shows the history of all programs started on the equipment with a HACCP data record
- A7 Active Cleaning automatic cleaning

B MANUAL MODE

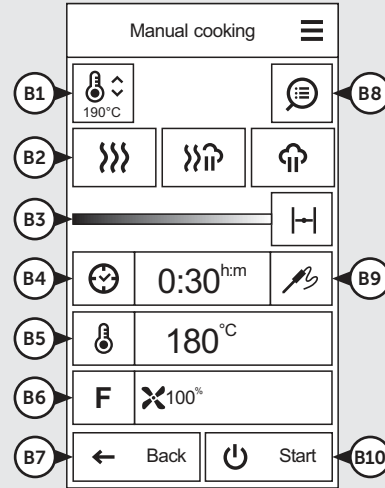

- B1 Option Preheat/Cool
- B2 Cooking mode selection
- B3 Humidity selection
- B4 Setting the time
- B5 Setting the temperature
- B6 Settings for other functions
- B7 Step back
- B8 Overview of program steps
- B9 Temperature probe settings
- B10 Start cooking

C PROGRAM DETAILS (QUICKVIEW)

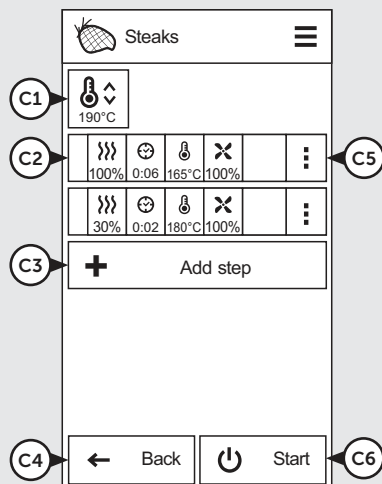

- C1 Option Preheat/Cool
- C2 Step parameters
- C3 Enter another program step
- C4 Step back
- C5 Enter/delete a program step
- C6 Start cooking

D END OF COOKING

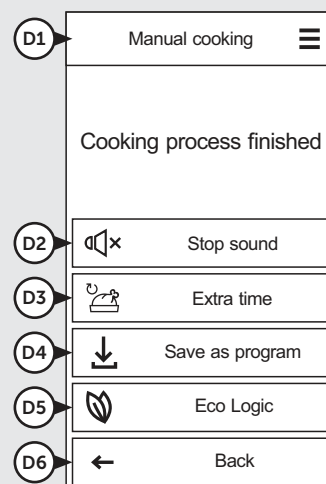

- D1 Information about the selected mode/ program for the cooking process
- D2 Disable the sound signal
- D3 Option to immediately extend the last cooking step
- D4 Save the completed cooking process as a program
- D5 Display power consumption during the cooking process
- D6 Return to the last screen before pressing the START button

TABLE OF CONTENTS

FOREWORD	4
ABOUT THIS MANUAL	5
01 BASIC INFORMATION ABOUT THE APPLIANCE	7
1.1 USE: WHAT IT'S FOR	7
1.2 DESCRIPTION OF THE APPLIANCE	7
1.3 OPTIONAL EQUIPMENT AND ACCESSORIES	7
1.4 CONTROLS: BASICS	8
02 SAFETY DURING USE	9
2.1 SAFE OPERATION	9
2.2 PROTECTIVE AIDS	10
2.3 PROTECTIVE ELEMENTS OF THE APPLIANCE	10
2.4 DANGEROUS LOCATIONS AND RESIDUAL HAZARDS	11
2.5 USING ACCESSORIES	13
03 CONTROLS	14
3.1 TOUCHSCREEN PANEL	14
3.2 OTHER BUTTONS	14
3.3 KEYBOARD	14
04 COOKING	15
4.1 MANUAL MODE	15
4.2 PROGRAMS	18
4.3 MULTITASKING	25
05 OTHER	26
5.1 LOW-TEMPERATURE BAKING	26
5.2 REGENERATION AND KEEP WARM	26
06 SETTINGS	27
6.1 BASIC SETTINGS	27
6.2 DATA HACCP	33
07 MAINTENANCE	35
7.1 DAILY MAINTENANCE	35
7.2 WEEKLY MAINTENANCE	37
7.3 HALF-YEARLY MAINTENANCE	39
7.4 YEARLY MAINTENANCE	39
08 AUTOMATIC CLEANING	40
8.1 AUTOMATIC CLEANING: WHAT YOU SHOULD KNOW	40
8.2 STARTING THE CLEANING PROCESS	41
09 ERROR MESSAGE TABLE	42
10 SERVICE LIFE, TAKING OUT OF OPERATION AND WARRANTY	44

FOREWORD

Dear customer,

Thank you for purchasing a product from Retigo s.r.o. We are a manufacturer and supplier of specialised professional culinary appliances with a long track record of success. We believe this appliance will help you implement your ideas with outstanding results in your daily work. With this appliance, you can produce meals of such quality that your customers will come back again and again.





We wish you lots of enjoyment and success in using the Orange Vision Plus.

ABOUT THIS MANUAL

This manual should help you to easily understand how to operate the Orange Vision Plus and inform you about its options and capabilities.

SYMBOLS USED IN THIS USER'S MANUAL

In this manual, you will find symbols with the following meanings:

SYMBOL	MEANING
	These symbols mean "ATTENTION" and "WARNING", they inform you about things that may cause serious injury to the user and/or damage to the machine. Furthermore, they indicate an important instruction, feature, method or issue that must be followed or considered when operating or maintaining the appliance.
	This symbol indicates useful information related to the appliance or its accessories.
	This symbol is a reference to another chapter in the manual.
	It indicates other procedure options that you may, but do not necessarily have to, apply.
	Dummy symbol for an icon of certain menus or programs and for pictograms.



VALIDITY OF DOCUMENTATION

This manual relates to RP type appliances and the following models:

ELECTRICAL MODELS

2E0623IA, 2E0611IA, 2E0611BA, 2E1011IA, 2E1011BA, 2E2011IA, 2E2011BA, 2E1221IA, 2E1221BA, 2E2021IA, 2E2021BA.

GAS MODELS

2G0611IA, 2G1011IA, 2G2011IA, 2G1221IA, 2G2021IA.

WHO IS THE MANUAL FOR?

This manual is intended for anyone who comes into contact with the appliance only during its maintenance or operation. These people must study the manual carefully before beginning any kind of work with the appliance.

ESSENTIAL INFORMATION

Study the manual carefully. The manual must be considered an inseparable part of the appliance. Therefore, keep it for future use.

Follow its instructions exactly, not only to make using the appliance easier, but also to ensure its optimal use and long lifetime.

Do not start the appliance unless you are thoroughly acquainted with all instructions, prohibitions and recommendations indicated in this manual, especially those in chapter "Safety during use".

The illustrations and pictures contained in this user's manual may not always correspond to reality, their purpose is the description of the main principles of the device.



The complete technology documentation for the appliance can be found at the manufacturer's website.

WHEN IN DOUBT

In practice, unforeseeable situations frequently arise that cannot be included and described in this user's manual. Therefore, when you're not sure what to do, always contact the manufacturer:

RETIGO s.r.o.

Láň 2310

756 61 Rožnov pod Radhoštěm

+420 571 665 511

INFO@RETIGO.CZ

WWW.RETIGO.CZ

If you have any questions or doubts, feel free to contact the trained professionals at the following telephone numbers:

PROFESSIONAL SALESPeOPLE:

+420 603 571 360

+420 604 568 562

PROFESSIONAL CHEFS:

+420 734 751 061

+420 727 867 220

PROFESSIONAL SERVICE TECHNICIANS:

+420 571 665 560

When contacting the manufacturer or trained professionals, please have your appliance's basic information ready. This information can be found on the model plate – see the chapter "Appliance identification".



A detailed description of the data indicated on the model plate can be found in the paragraph "Appliance identification".

ORGANIZATION OF CUSTOMER DOCUMENTATION

The customer documentation is made up of two parts:

- Transport and installation instructions
- Operating instructions

THE MAIN TOPIC OF THE TRANSPORT AND INSTALLATION INSTRUCTIONS

- **Basic information:** describes the functions and main parts of the appliance relevant to its installation
- **Safety:** describes safety and appropriate measures during installation
- **Transport:** contains the necessary information about moving the appliance and handling it at the installation site
- **Placement:** describes and specifies rules for selecting the installation site
- **Installation:** describes set-up of the appliance, making the electrical connections, connecting the gas (for gas models only), connecting the water and drain, and finally the start-up.
- **Decommissioning:** describes the necessary tasks at the end of the appliance's lifetime, including its disposal.
- **Technical data:** contains all dimensional sketches and connecting dimensions

MAIN TOPICS IN THE USER'S MANUAL

- **Basic information:** describes the functions and main parts of the appliance relevant to its installation
- **Safety:** describes safety and appropriate measures during installation
- **Controls:** describes the appliance's main control elements
- **Software operation:** contains instructions for working with the control software when cooking, describes settings, data import and export
- **Cleaning:** describes cleaning methods, work procedures and steps for cleaning and the **operator's handling of the appliance**

Maintenance: contains the instructions, maintenance plan, and handling of the appliance during maintenance

APPLIANCE IDENTIFICATION

The model plate is on the right side of the appliance at the bottom. The model plate lists the appliance's manufacturer, technical data on the appliance and the CE mark, indicating that the product complies with all requirements of the standards ČSN, EN, IEC and government decrees.

Electrical models

A – Brand name

B – Model

2E – heat generation

method:

E – electric

1221 – machine size: 0623, 0611, 1011, 2011, 1221, 2021

I – steam generation

method:

I – injection

B – boiler

A – motor fan control

method:

A – frequency converter

Z – without frequency converter

C – Electrical parameters



Gas models

A – Brand name

B – Model

2G – heat generation

method:

G – gas

0611 – Machine size: 0623, 0611, 1011, 2011, 1221, 2021

I – steam generation

method:

I – injection

A – motor fan control

method:

A – frequency converter

Z – without frequency converter

C – Electrical parameters

D – Gas parameters



01 | BASIC INFORMATION ABOUT THE APPLIANCE

1.1 USE: WHAT IT'S FOR

The Orange Vision Plus combi oven is a universal appliance for preparing meals, including complete menus. It can be used for all types of food preparation methods based on heat, for example baking, frying, grilling, stewing, steam cooking, low-temperature overnight cooking, etc. The process is performed either in manual mode or in automatic mode utilising programs.

CORRECT USE OF THE APPLIANCE

- The appliance can be used only for heat preparation of various types of food. This involves steam, hot air or a combination of the two. The food must always be placed in standardized gastronorm containers, baking trays dimensioned for baking or standard accessories exclusively from the manufacturer.
- The cooking containers that are used must be made of stainless steel, ceramics, heat-resistant plastic or enamelled steel.
- The appliance is exclusively for professional use in the culinary field.

LIMITATIONS ON THE USE OF THE APPLIANCE

The following must not be placed in the appliance:

- no food in enclosed jars or packaging
- no easily flammable items with an ignition point lower than 260 °C, such as for example low flash point oils, fats, wipes (wiping cloths)
- no dry powder or granulate

1.2 DESCRIPTION OF THE APPLIANCE

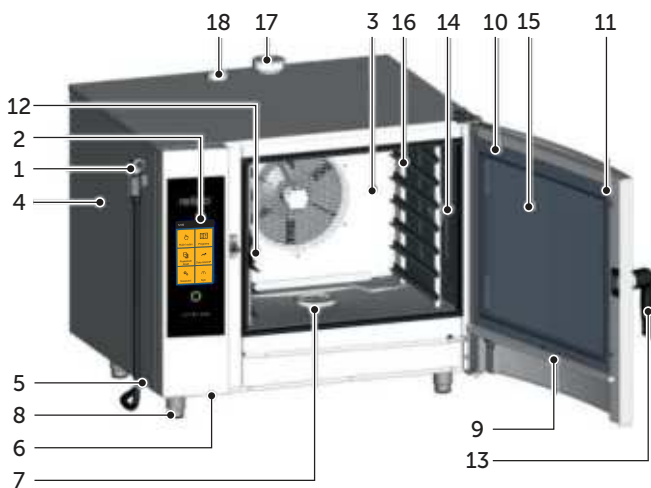

1. Hand shower (optional equipment)
2. Control panel
3. Detachable interior wall in front of fan
4. Side cover
5. Air and dust filter
6. USB connector
7. Drain cover

8. Height-adjustable legs
9. Condensation drip pan for the inner glass with automatic draining
10. Door with rounded exterior glass
11. Inner glass fastening clips
12. Temperature probe (optional equipment)
13. Door handle
14. Interior lighting
15. Openable inner glass of the door
16. Gastronorm container racks
17. Excess steam venting flap (optional equipment)
18. Venting chimney



Any use of the appliance beyond this application areas, including modifications to safety or operational components without the manufacturer's permission, is considered to constitute use not conforming to its purpose. The company accepts no liability for damages resulting from such use; the user bears all risk.

The user is also responsible for abiding by the conditions prescribed by the manufacturer for installation, operation and maintenance of the appliance, which must be maintained and repaired only by persons familiar with it and instructed on its hazards.

1.3 OPTIONAL EQUIPMENT AND ACCESSORIES

OPTIONAL EQUIPMENT

The standard configuration of Retigo Orange Vision Plus combi ovens includes automatic cleaning, and 99 programs with 9 steps.

Optional equipment that can be purchased:

- Temperature probe
- Excess steam venting flap
- Standard hand shower
- Self-winding hand shower (excluding size 623).

OPTIONAL ACCESSORIES

GASTRONORM PANS AND BAKING TRAYS

Gastronorm pans and baking trays serve not only as containers for cooking and baking, but are also suitable for transporting, serving and storing the meals. They significantly contribute to higher work efficiency - when one plans their work properly, it is often unnecessary to transfer cooked or baked meals from one pan or tray to another.



Adhere to workplace safety codes when handling gastronorm containers, see 2. SAFETY DURING USE.

STANDS, RIDE-IN TROLLEYS AND BRACKETS

Essential accessories for the combi oven include various stainless steel stands, wall brackets (on model 623) and ride-in trolleys (on sizes 1011, 2011, 1221, 2021). Special equipment is considered to be banquet baskets, trolleys and thermoboxes used for serving meals.

VISION VENT HOOD

The Vision Vent condensation hood will enable you to comfortably maintain a pleasant climate in your kitchen thanks to strong exhaust performance and intelligent switching. The Vision Vent is designed for the combi ovens Retigo Vision 623, 611, 1011 and 2011.

OIL GUN

An oil gun is a special tool that allows one save up to 2/3 of the costs related to oil consumption for cooking, or when frying in the appliance. Thanks to the narrow nozzle, one can perfectly coat the food with a very fine layer of oil, and maintain the beautiful colour of fried foods while keeping oil consumption to a minimum. Thanks to the exchangeable nozzle, the oil gun can be used for other viscous materials used in the food industry, such as chocolate.

VISION SMOKER

The Vision Smoker smoke generator is a simple accessory compatible with Orange Vision Plus and all Retigo combi ovens. Thanks to simple controls, with the option to smoke up to three hours non-stop and its simple maintenance, the Vision Smoker will enable you to liven up the offered meals or to expand the menu with smoked specialties.



When working with the oil gun and the Vision Smoker, adhere to workplace safety as described in the user manuals for this appliance.

1.4 CONTROLS: BASICS

TURNING ON AND OFF

The appliance is permanently connected to the power grid and it is turned on and off by pressing an external main power switch. Its location is determined by the operator of the appliance upon installation and you as the user must be informed of its placement. During ordinary use, it is enough just to put the appliance into Standby mode by pressing the white circle under the display and then the Standby button.

OPENING AND CLOSING THE DOOR

The combi oven's door is equipped with a closing mechanism that allows right- or left-handed opening. Moving the lever to the side will release the door latch. Pull on the handle to open the door.

To close the door, push on the handle (by slamming). If you have an appliance with the ride-in trolley (2011, 1221, 2021) close the door and turn the door handle clockwise by 90°.

PREHEATING THE BOILER (combi ovens with a boiler)

When the combi oven is turned on, the boiler is automatically filled with water which is then heated. For this time, the start of the program will be temporarily disabled in the "Steam" and "Hot air with steam" modes, until the boiler is fully heated. After this time, the combi oven will automatically continue running.

02 | SAFETY DURING USE

The appliance cannot be operated without a certain amount of caution, alertness and common sense. Even though the appliance has been designed and manufactured to meet all international safety standards, the user bears primary responsibility for his or her personal safety while operating the appliance. The manufacturer of the appliance bears no responsibility for personal injury, equipment damage or environmental damage caused by failure to operate the appliance according to the manual or by failure to follow applicable safety regulations.

This chapter provides the most important information on working safely and protecting the health of the user and all others who come into contact with the appliance or its accessories.

2.1 SAFE OPERATION

GENERALLY

- The appliance may only be used by personnel authorised, qualified and trained for operating it. Persons who are not authorised to use and have not been trained in its operation must never be allowed to handle or maintain it, or to perform any activity contrary to its use. Such unprofessional activity may cause injury or damage the appliance.
- Arrange for regular training on how to operate the appliance. This prevents occupational injuries and damage to the appliance.
- This appliance is to be used only for food preparation and in compliance with the manual. Any other use is in conflict with its purpose and is considered dangerous.
- For safety reasons, do not remove the hard covers or try to get inside the appliance - risk of injury by electrical shock. The device contains no components that the user can handle. Repair of any defects or maintenance beyond that described in this manual must be done by a qualified service technician.
- Do not install any heat sources in the immediate area of the appliance (such as fryers, grills, cookers, hot plates, etc.).



Detailed requirements related to the location of the appliance are provided in the transport and installation instructions.

- Do not work with the appliance if you suffer from dizziness, fainting or other weakness or lack of concentration or if under the influence of drugs or alcohol!
- It is strictly forbidden to remove or damage the labels fastened to the appliance.
- Only operate the appliance in perfect working order. Do not make any changes to it.
- Follow the prescribed inspection plan, follow the instructions in the user's manual, adhere to generally applicable regulations for gas appliances.
- Do not place anything near the appliance that you could trip over. Keep the workplace (including access ways) clean and tidy.

OPERATING ENVIRONMENT FOR THE APPLIANCE

- The permitted ambient temperature range is +4°C to +35°C.
- The environment must not be explosive or toxic.
- A fire extinguisher or an automatic fire extinguishing system must not be located directly above the appliance.
- There must be no flammable materials, gasses or liquids located underneath or next to the appliance.

BEFORE USING THE APPLIANCE

- Before starting the appliance, it is absolutely necessary to study the chapter "**Safety during use**", along with this chapter.
- If you have any doubts about the appliance's installation, operation or safety, contact your supplier.
- In the event that any damage occurs to the electrical equipment, it is necessary to organise repairs without delay; a damaged appliance must not be used.
- Do not block the appliance's vents with objects, and especially do not place cooking utensils, fabrics or other items on the appliance. Make sure that steam freely escapes from the vents at the top of the appliance.
- Before using, check the appliance's cooking chamber. Remove all remaining food, cleaning agent residues or other objects, and thoroughly rinse the cooking chamber with the hand shower.
- Be sure not to sprinkle or spray water on the appliance, and do not place objects filled with water on it.
- Do not place sources of open flame on or near the appliance.

DURING USE OF THE APPLIANCE

- Do not continue using the appliance if you have the slightest doubt as to its safe operation or whether it is damaged. Turn it off immediately, unplug the power cable, shut off the water supply, and contact your supplier.
- If noise increases beyond the permitted limit while the while you are using the appliance, stop the appliance and fix the cause.
- Immediately report all faults to your superior, who must arrange for their repair.
- Do not leave the appliance unattended while it is turned on, unless explicitly instructed to by the manual.
- Use only your fingers to operate the control panel buttons. Using sharp, pointed or other objects to operate the appliance voids the warranty.
- When working with the appliance, be aware that gastronorm containers, cooking inserts and grates can be hot. The temperature of the external glass on the door may reach temperatures higher than 60°C. In all cases there exists a risk of burns.
- Hot steam is generated while the appliance is running – when the door is opened, there is a risk of scalding, etc. When opening the door, especially during steam operations, always stand in such a way that you cannot be scalded by the steam escaping from the open door. Open the door only partially and do not open fully until the steam has escaped.
- If gastronorm containers are more than three-quarters filled with liquid, greater care must be taken when handling and removing them. When placing containers this full into the appliance, put them only in racks into which you can see. Otherwise, the user may be scalded. Take great care when removing hot gastronorm containers – whatever their content!
- Be especially careful when working with an appliance (set of appliances) whose highest rack is 160 cm or higher above the ground. Here there is a risk that the gastronorm container may flip over and cause burns.
- Hot areas may form during the cooking process, especially on the cookware, grills and the inner side of the door. Use protective gloves whenever handling hot objects.
- It is forbidden to start the fan without the cover. If the appliance is equipped with a ride-in trolley, then you must always brake the trolley once inside the appliance. When handling a full trolley, the gastronorm container locking mechanism must always be used (GNs are closed).
- When transporting gastronorm containers filled with a liquid, they must be covered with sealing lids. Otherwise, the user may be scalded.

- In the event that the floor is very uneven, ride-in trolleys must not be used for riding into or out of the appliance. Never leave the trolley handle inside a closed appliance. This may break the appliance's door. Do not pull the ride-in trolley without the handle designed for this purpose. Otherwise, this may result in burns.
- When using banquet trolleys, always make sure that the plates are correctly seated on the stands.
- For cleaning the trolleys, always use the automatic cleaning program (if available). Otherwise, use cleaning products designed for semi-automatic cleaning. It is not permitted to use the appliance without the ride-in trolley for standard work and automatic cleaning!

AFTER YOU HAVE FINISHED WORKING WITH THE APPLIANCE

- Perform cleaning and service only when the appliance is cold!
- Remove solid pieces of food by taking them out of the cooking chamber – never flushing them down the appliance's drain.
- Cleaning and descaling agents are to be used only according to the instructions in this manual and in compliance with the instructions for the individual agent.
- After work (e.g. overnight), leave the appliance's door ajar.
- When the appliance is not used for an extended period of time, shut off the water and power supply.

WHEN CLEANING

- Use extra caution when handling cleaning agents. Contact with cleaning agents and their fumes poses a hazard of burns or irritation to skin, eyes and respiratory organs.
- When handling cleaning agents, wear safety equipment.
- When dosing powdered cleaning agents, be extra cautious that they are not inhaled and do not come into contact with eyes and mucous membranes.

2.2 PROTECTIVE AIDS

When operating the appliance, it is also necessary to wear the right clothes and use personal protection gear. Clothing, shoes and protective gear must comply with national safety requirements for your type of work. Especially do not forget to use these important items:



When working with the appliance, we do not recommend wearing:

- Scarves, neck ties, chains, watches, bracelets, keys, rings or other metal objects, or work with an inappropriate bandage on.
- Electrical components such as heart pacemakers, watches, credit cards, etc., or other items with magnetic recording media.
- Long, loose hair. Secure long hair with an appropriate head covering.

2.3 PROTECTIVE ELEMENTS OF THE APPLIANCE

The appliance is equipped with safety elements that make it safer to operate. Here is a list of the most important ones:

1. External main switch
2. External covers
3. Safety temperature limiter
4. Control panel
5. Door with magnetic switch
6. Ventilation position of the appliance's door
7. Internal wall

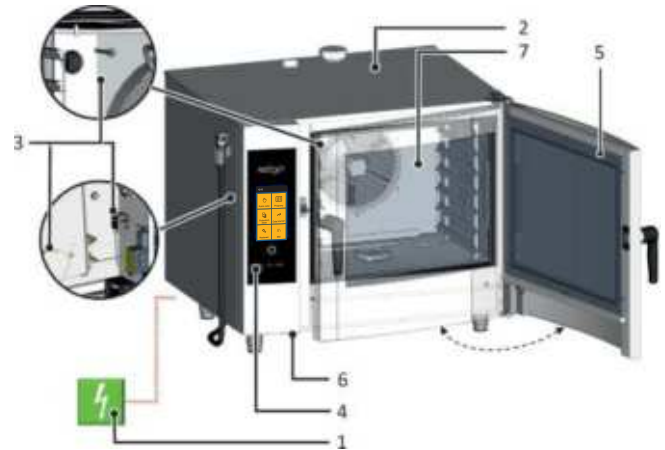

⚠

None of the elements below are intended to be removed by the operator. They can be removed for inspection, maintenance or repair only by a person qualified for the task.

EXTERNAL MAIN SWITCH

The appliance is designed for permanent connection to the power grid. Connect and disconnect the power supply using an external main switch. The switch is used for turning the appliance on and off (when starting operation, making repairs, installing, and also in emergencies). The external main switch must be easily accessible at all times!

⚠

It is forbidden to tamper with safety circuits, to remove the side covers, or to perform any unauthorised changes, which change the reliability and safety of these circuits.

EXTERNAL COVERS

All removable covers are firmly connected to the appliance, so they can be removed only with tools. Covers prevent unintentionally touching parts carrying electricity. Always check whether the covers are in place.

SAFETY TEMPERATURE LIMITER

Safety temperature limiters are located in the cooking chamber, boiler and electrical panel. When there is excessive temperature, these elements activate and turn off the appliance. When there is excessive temperature, these elements activate and turn off the appliance.

If a safety limiter fails, an error code is displayed accompanied by an audible signal.

CONTROL PANEL

The control panel is located outside the area prone to high temperatures and makes it possible to quickly turn off the appliance using the STOP button. The display also shows malfunctions.

The control panel is securely fixed to the front control panel and prevents unintentionally touching conductive parts. It can be removed only with a tool.

DOOR WITH MAGNETIC SWITCH

The moment the door opens, the heat automatically shuts off and the fan quickly stops to limit the escape of steam from the cooking chamber. To protect against steam scalding, first open the door slightly and wait a while before opening it fully. To close the door, push on the handle (by slamming).

If the door is not closed properly and the appliance is in the **Start** mode, a "close door" prompt will appear.

VENTILATION POSITION OF THE APPLIANCE'S DOOR

To protect against steam scalding, the door can first be opened slightly. In this position, the door remains partly locked. Once steam stops coming out of the cooking chamber, the door can be opened completely.

INTERNAL WALL

It is always located inside the cooking chamber in front of the fan so as to prevent striking against the fan's rotating wheel. The internal wall can only be removed with tools.



Under no circumstances should you remove any safety or protective element of the appliance! Do not make any changes to it without the permission of the manufacturer.

2.4 DANGEROUS LOCATIONS AND RESIDUAL HAZARDS

The appliance is designed so that when properly used in perfect technical condition, it poses no danger to the operator or surroundings. Nonetheless, during its operation, situations may arise that could be dangerous if the user is not aware of them. These are called residual hazards — those that remain even after all preventive and protective measures have been considered and implemented. Spot these hazards early and avoid them.

Dangerous locations, types of hazards and their effects.

COOKING CHAMBER

While it is running, the appliance generates high-temperature steam in the cooking chamber.



- Burning hazard from hot places throughout the chamber.
- Burning hazard from side handles (ladders/racks) of gastronorm containers and other accessories used when heating food.
- Scalding hazard from hot steam escaping the cooking chamber when the appliance's door is opened.

FAN

In the appliance's cooking chamber, behind the internal wall, there are one or more circulating fan wheels.



- Hand injury hazard from careless handling in the cooking chamber behind the inside wall when it is not properly installed in place.
- Hand injury hazard from careless handling in the cooking chamber behind the inside wall during cleaning or maintenance.

DOOR

The inside of the door and especially the internal glass heat up to a high temperature when the appliance is running. The appliance also generates hot steam that escapes when the door of the cooking chamber is opened.



- Risk of burns from the inside of the door when opening the door during or after the cooking process.
- Risk of scalding by hot steam and fumes when opening the appliance, and especially when the top of the door is at face level, as it is with sets of appliances.

UPPER COVER OF APPLIANCE

Never cover the appliance or place on it any objects that may catch fire. Your appliance is not a storage shelf!

Be careful and use safety gloves.



- Risk of burns during the cooking process.
- Fire hazard if the cover is covered or if flammable materials are on the cover during the cooking process.

GASTRONORM CONTAINERS

Never handle containers above eye level that contain hot liquids or hot liquid food, and always use safety gloves.



- Risk of burns during improper handling of hot accessories when removing them from the appliance after cooking.

FLAP AND CHIMNEY

Do not place any part of the body above these parts and always use safety equipment (gloves, safety glasses, etc.).



- Burning hazard from steam escaping during the cooking process.

HAND SHOWER



- Scalding hazard from hot steam or hot fat when spraying a hot cooking chamber.
- Do not use the hand shower for cooling down the cooking chamber or for cleaning when its temperature is greater than 90 °C.
- Scalding hazard from hot fat and steam when water splashes into hot fat.
- Do not spray water directly into hot fat — this may cause spattering and intense steam generation.

Residual risks

To further reduce risks and to ensure the effectiveness of safety protection, we provide information about residual risks. To eliminate them, we have established the following technical and organizational measures for implementation by the user. These are intended to overcome the respective hazards.

ELECTRICAL CURRENT

All of the appliance's electrical components are powered by potentially fatal current. The power supply terminals and other electrical components remain under live voltage even when the appliance is turned off.



- The power supply terminals and other electrical components remain under voltage even when the appliance is turned off.

However, access to the area with electrical components is only possible after removing a rigid cover. As the user, you are not authorised to service the appliance's electrical components. There is only a hazard in the event that power supply cables of the appliance are damaged, e.g. by means of being inappropriately placed, twisted, pinched, weighed down, etc. Moreover, if the appliance moves by itself on the wheeled frame, this may break the power supply cable.



- When operating the appliance, always lock the wheels with the parking brake!

If there is any damage to the electrical equipment, it is necessary to stop using the appliance immediately and arrange immediate repair by an authorised service centre.

If it is not necessary to have the appliance under live current, disconnect the main power supply connection by turning off the main power switch.

MECHANICAL PARTS

Hazards arise only when the appliance has been installed on a wheeled frame or has been installed incorrectly (such as with a strong tilt, not anchored on a slippery or unstable surface, etc.), and its unexpected movement may cause crushing or pinching when it loses stability.



- If you think that the appliance is incorrectly installed in regard to stability, do not continue working, and immediately contact the owner to check the installation.
- Injury hazards from moving parts occur in situations where the cooking chamber is cooled with the door open — "Cool down" function, the internal wall in front of the fan is missing, so that the fan wheel is freely accessible.

When handling the appliance, adhere to the the relevant regulations for tying loads and the handling of lifting equipment.



- Make sure that the internal wall is always in its place and properly secured against loosening!
- Risk of hand injury may occur when sliding or pulling out the loading trolley or loading basket.
- When handling loading accessories, always use the handle provided for the purpose.

HIGH TEMPERATURE

During the cooking process, the appliance's interior heats to a high temperature, including containers and food that have been inserted, and after the door of the cooking chamber is opened, this heat escapes to its surrounding. For this reason, there is risk of burning or scalding when working with or near the appliance.



- Risk of burns from hot surfaces mainly occurs in the entire cooking chamber, including the inside of the door, and on all parts that are or have been inside during cooking, such as cooking containers, handles of cooking containers and grates.
- Wear the prescribed safety clothing, especially safety gloves!
- A scalding hazard from hot steam can occur when water is sprayed into the warmed-up cooking chamber or the door is open during "Cool down" function.
- Step far enough away from the appliance, and do not spray water into the warmed-up cooking chamber for fast cooling or when rinsing with the hand shower!



- A scalding hazard occurs when water is sprayed into the appliance when there is container containing hot fat inside it.
- Do not spray water into hot fat!
- There is also a water scalding hazard during improper handling of the gastronorm containers, when using gastronorm containers of inappropriate dimensions, and when using a plate of inappropriate dimensions in relation to the handle of the banquet trolley plate handles.
- When handling containers that contain hot liquids or hot liquid food, use extra caution and always use safety gloves.

WASHING DETERGENTS

When washing detergents are used, there is a risk of burning or irritation to the skin, eyes and respiratory organs from direct contact with the cleaning agent or its fumes.



- Avoid direct contact with washing detergents. If there is risk of contact, use safety gloves.
- When dosing, be especially careful not to inhale the detergent.
- During fully automatic cleaning, do not open the appliance's door unless prompted by the software — there is danger of inhaling washing detergent fumes or splashing skin and eyes.

FOOD CONTAMINATION

When cleaning or descaling agents are used incorrectly, the area around the appliance, where food is usually prepared, may become contaminated. This may result in food contamination.



- Make sure the work surface has not been splashed with washing detergent or descaler!
- Do not place empty containers on the work surface – the food may get contaminated!

WATER

If the appliance and its wheeled cart begin making undesired movements, this may break or damage the water supply line, and the escaping water may cause slips and falls.



- Before operation, always check that the wheels are locked with the parking brake! Keep the appliance's work area and surroundings clean and dry!

- Never spray water from the hand shower on to hot door glass – this can destroy it!
- After use, always place the hand shower in its holder.

2.5 USING ACCESSORIES**TEMPERATURE PROBE**

When using the temperature probe, adhere to the following:

- Use the probe only for inserting into food.
- Do not insert the probe into frozen food. This can break it!
- Never forcefully bend the temperature probe's power cable.
- Never pull the probe out of the food by the cable.
- Place the temperature probe into the food in such a way that it does not lean against the door glass.
- The temperature probe may be hot – use safety gloves.
- Pull the temperature probe out of the food before removing the food from the appliance and place it into the probe holder.
- When the probe is not in use, keep it in the probe holder.
- Never leave the temperature probe hanging outside the cooking chamber – the door may close on it and damage it.

HAND SHOWER

When using the hand shower, adhere to the following:

- The hand shower may only be used for cleaning the cooking chamber.
- The hand shower works for only two minutes after the door is open. After this, it turns off automatically.
- Never use the hand shower when the appliance is hot. Allow it to cool down to under 65 °C.
- Never use the hand shower for cooling down the cooking chamber when the temperature inside the cooking chamber is higher than 90 °C – this may destroy the inner glass of the door and cause deformation of the cooking chamber!

03 | CONTROLS

3.1 TOUCHSCREEN PANEL

The meanings of buttons (icons) found on the most common screens is provided on figures A, B, C, D. The basic button functions are selected by gently tapping on the icon on the panel. The extended functions are then activated by pressing and holding down the button for longer than 2 seconds.

FREQUENTLY RECURRING BUTTONS

The system has buttons that are common for the individual modes and functions of the appliance. Their meanings are as follows:

	Back	Press the button to go to the previous step.
	Ok	Press the symbol to confirm your selection.
	Start	Press to start the desired cooking process, cleaning, etc.
	Stop	Press to stop the current cooking process and display it on screen D.

3.2 OTHER BUTTONS



The Vision button serves to:

- switch to Multitasking mode 4/4.3
- turn on the control system
- put the appliance into standby mode.
- screen calibration mode after holding down the button for more than 2 seconds



Pressing the symbol will display the main screen (A).



When pressed, the control system will go into sleep mode and the screen will turn off. The sleep mode is indicated to the user by the regular flashing of the Vision button. The system is woken up by pressing the Vision button.



Pressing this button will reduce power input to the appliance by half, thanks to which power is saved while the appliance is idle.



Press it to permanently illuminate the cooking chamber and press it again to turn the light off. Lighting it is only lit when the cooking chamber door is opened.



Press to show or hide further lines that offer extended functions of the appliance.

3.3 KEYBOARD

The system also has keyboards. They are controlled in the same way in all modes and functions of the appliance.

BASIC NUMERICAL KEYPAD

Serves to enter values.

		Delete values.
		Quick correction of values.
		Non-stop time, non-stop performance of a function.

EXTENDED ALPHANUMERICAL KEYBOARD

For entering letters, symbols and numbers.

		Change case.
		Toggle between a keyboard with letters and a keyboard with numbers/symbols.
		Delete characters.
		Space bar.
		Keyboard options. Select language and style (QUERTY-QUERTZ).
		Toggle between a keyboard with numbers/symbols and a keyboard with letters.
		Delete characters.
		Space bar.

04 | COOKING

4.1 MANUAL MODE

This option is utilised by users, who want to have the cooking process parameters set exactly according to their requirements. Set the cooking parameters manually according to your own discretion and experience.

Pressing option A2 will display the **Manual mode** (B).

B1 COOKING CHAMBER PREHEATING

Off. 

On.
The value below the symbol is set at the factory to 15°C higher than the cooking process temperature you have set (B5). This means that whenever you manually set the cooking process temperature with active preheating, the preheating temperature automatically increases by 15°C. The only exception is the Steaming mode, in which the preheating temperature corresponds to the set process temperature.



i The increase value can be changed in the user settings (06 SETTINGS/6.1/Cooking/Preheat/Temperature increase).

The preheating temperature can also be manually set in the range 30°C - 300°C by pressing and holding down the preheating symbol. This allows the creation of a program containing a single step with automatic preheating with a precise temperature. If, after it is started, the temperature in the cooking chamber is significantly lower, it is possible to open the door without stopping the rotation of the fan. The fan will continue at the standard RPM and will blow hot air out of the chamber. As soon as the temperature in the chamber reaches the set preheat temperature, the fan will stop automatically.

B2 COOKING MODE SELECTION

HOT AIR
Substitutes for baking in a pan, in an oven, frying in a deep fryer, etc.
Temperature range: 30-300° C 

HOT AIR WITH STEAM (COMBINATION)
Substitutes for baking requiring basting or procedures, where the meal requires a certain humidity percentage, while simultaneously cooking it with hot air, etc. 

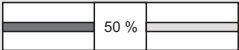
The amount of steam in the cooking chamber can be set by moving the slider or tapping on the percentage value and entering it using the numerical keypad. 

Temperature range: 30-300 °C

STEAMING
Substitutes for cooking in water.
Temperature range: 30-130 °C 

B3 SETTING THE HUMIDITY
HOT AIR mode is shown by a flap symbol, and moving or tapping the scroll bar allows the following settings: 

Fully open flap valve; continuous venting of humidity from the cooking chamber. 

The system controls the opening/closing of the flap valve itself according to the set percentage of humidity. 

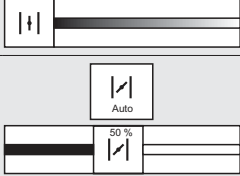
Fully closed flap valve; all the humidity stays in the cooking chamber. 

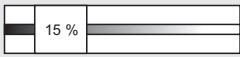
In Combination mode, humidity is displayed as a percentage, which can be changed by moving the scroll bar in a range from 0% to 100%. 

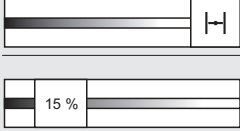

NOTE:
In STEAMING mode, the humidity is a fixed setting and cannot be changed. 

B4 SETTING THE TIME
Set the cooking process time.
Time range: 00:01-23:59 (h:m) 

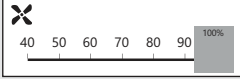

B5 COOKING PROCESS TEMPERATURE
Set the cooking process temperature.
The temperature range depends on the used cooking mode. 

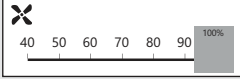
B6 SETTINGS FOR OTHER FUNCTIONS 











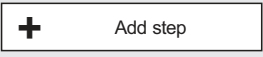

FAN SPEED
Set seven fan speeds. 

FAN TIME CONTROL
The fan will rotate only:
- when the heating elements are on. 
- for 10 seconds when idle for longer than 2 minutes. 

NOTE ON THE STEP
Allows text comments to be written, which will display upon transition to the relevant program step. The comments are accompanied by an audible signal. 

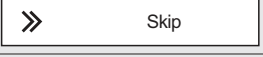
<p>B8 OVERVIEW OF PROGRAM STEPS Shows an overview of all the set cooking parameters. Enables the changing of settings, adding another step or reading of chef's tips. For a detailed description, see screen C.</p>	
<p>B9 TEMPERATURE PROBE Setting the temperature probe temperature Allows the cooking process to be controlled by setting the final temperature at the centre of the food. Temperature range: 30-110 °C</p>	
<p>DELTA T Allows a constant difference to be set between the temperature at the centre and that in the cooking chamber. Temperature range: 20-70 °C</p>	

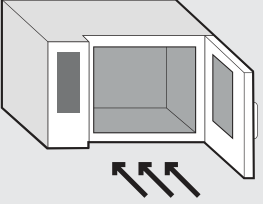
4.1.1 Cooking with manual settings

<p>1 GO TO MANUAL MODE</p>	
<p>2 SELECT AND ADJUST THE AVAILABLE PARAMETERS AS REQUIRED</p>	
<p>2.1 OPTION: ADD A STEP</p> <p> Press</p>	
<p>Press</p>	
<p>Select and edit the parameters B1 to B9 as required</p>	
<p>To add another step, repeat the procedure from point 2.1</p>	
<p>2.2 OPTION: SAVE AS AUTOMATIC START</p> <p> If you want the program to automatically start repeatedly at a specific day and time, proceed according to chapter 4.2.10.</p>	
<p>3 START THE COOKING PROCESS BY PRESSING</p>	
<p>4 WAIT FOR THE COOKING CHAMBER TO PREHEAT OR COOL DOWN</p>	
<p>4.1 OPTION: SKIP PREHEATING/COOLING</p> <p> Press</p>	
<p>4.2 OPTION: END THE COOKING PROCESS</p> <p> Press</p>	
<p>5 INSERT THE FOOD After preheating or cooling down the cooking chamber, you will be requested to insert the food. Inserting the food and closing the door will start the cooking process.</p>	
<p>5.1 OPTION: TURN OFF THE SOUND SIGNAL</p> <p> Press</p>	

6 AT THE END OF THE COOKING PROCESS, SELECT AN ACTION WITH WHICH TO CONTINUE (screen D)

6.1 OPTION: EXTEND THE TIME OF THE LAST COOKING STEP

Press 

6.2 OPTION: SAVE THE PROCEDURE TO THE PROGRAMS

Press 

Select a folder or sub-folder, where you wish to store the new program

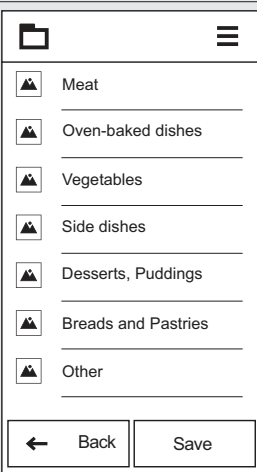

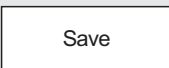
Press 

Enter the name of the program 

Press 

In the QuickView preview, you can check all the steps of the cooking program.



Press 

6.3 OPTION: OVERVIEW OF THE COOKING PROCESS STATISTICS

Press 

6.4 OPTION: TURN OFF THE SOUND SIGNAL

Press 

6.5 OPTION: RETURN TO THE MAIN SCREEN

Press 

4.2 PROGRAMS

The Program mode enables the combi oven to be utilised to the maximum extent possible, with ultimate control comfort ensuring that the final products are repeatedly of the highest quality.

PROGRAM SYMBOLS

	Programs	Main category according to meal type (category).
	Meat	Subcategory with more programs
	Steaks	Program
		Newly created program with no pictogram assigned.

4.2.1 Cooking according to a program

1 ENTER THE PROGRAMS

Press



2 SELECT A PROGRAM CATEGORY

If necessary, select an appropriate sub-category

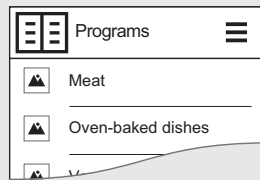

3 SELECT EDIT MEAL (PROGRAM)

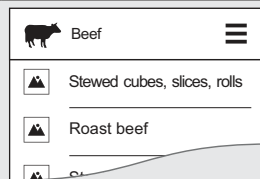

4 PROGRAM PREVIEW APPEARS (QUICKVIEW)

All the program steps are shown on a single screen with the option of quickly editing or adding another step.



4.1 OPTION: EDIT PARAMETERS

Select and edit the parameters as required

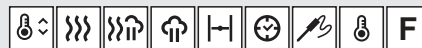

4.2 OPTION: ADD A STEP

Press

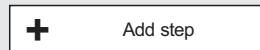

To add another step, repeat the procedure from point 4.1

4.3 OPTION: START A PROGRAM FROM THE SELECTED STEP

Press



Select

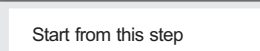

4.4 OPTION: DELETE STEP

At steps that you wish to delete, press



Select



4.5 OPTION: SAVE AS AUTOMATIC START











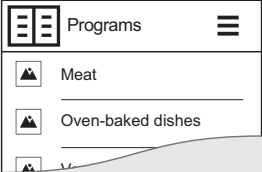

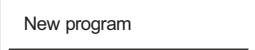

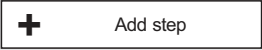
If you want the program to automatically start repeatedly at a specific day and time, proceed according to chapter 4.2.8.

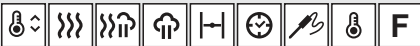

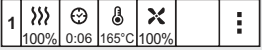
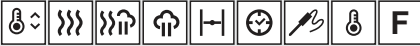
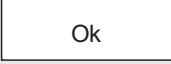
If after the cooking process you do not select the option Save as program, then the changes to the program performed in steps 4.1 to 4.5 will not be permanent, i.e. they apply only once when the program is started. When opened the next time, the program will have the original structure.

5 START THE COOKING PROCESS BY PRESSING	
6 AT THE END OF THE COOKING PROCESS, SELECT AN ACTION WITH WHICH TO CONTINUE (screen D)	

4.2.2 Create a new program

1 ENTER THE PROGRAMS Press	
2 SELECT A PROGRAM CATEGORY IN WHICH YOU WISH TO CREATE A NEW PROGRAM	
3 PRESS	
4 PRESS	
5 ENTER THE NAME OF THE PROGRAM	
6 PRESS	
7 PROGRAM DETAILS WILL BE SHOWN (screen C)	
7.1 OPTION: ADD PROGRAM STEPS	
 Edit the parameters as required	
Press	
7.2 OPTION: STEP PARAMETER SETTINGS	
 Press the step that you wish to edit	
Edit the parameters as required	
Press	
7.3 OPTION: INSERT A STEP	
 At the step, above which you wish to insert a new step, press	
To insert it, select button	
7.4 OPTION: DELETE STEP	
 At steps that you wish to delete, press	
To delete it, select button	

8 PRESS

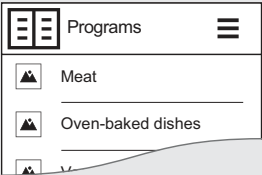

9 THE NEW PROGRAM IS SAVED

10 RETURN TO THE PROGRAMS



4.2.3 Editing a saved program

1 ENTER THE PROGRAMS
Press



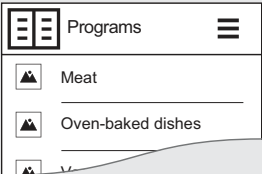

2 SELECT A PROGRAM CATEGORY IN WHICH YOU WISH TO EDIT A PROGRAM



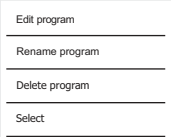

3 SELECT THE PROGRAM YOU WISH TO EDIT AND HOLD IT DOWN FOR LONGER THAN 2 SECONDS

4 FROM THE MENU, SELECT THE MODIFICATION THAT YOU WISH TO MAKE



4.1 OPTION: EDIT A PROGRAM
 It is possible to change the name of the program, parameter settings, add or delete a step. The procedure is similar to creating a new program.

4.2 OPTION: RENAME A PROGRAM
 Rename a program using the alphanumerical keyboard.

4.3 OPTION: DELETE A PROGRAM
 Permanently delete a program after confirming.

4.4 OPTION: SELECT
 Select the current program or multiple programs by ticking fields and subsequently copy or move them to a different category of programs or delete them.
 After selecting a program(s), press and select one of the offered options.

4.5 OPTION: MOVE UP/DOWN
 Move any program to a different location in the program list.

Return to the program list and press



Select



Press and hold down any program and drag your finger to move it to a new location.

Press

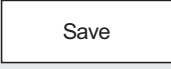

4.2.4 Create a program on a PC and load it on to the appliance from a USB disk.





Programs for the appliance can also be created and edited using your computer in a special software program **VisionCombi software**.







If you wish to load your own program created on your computer on to the appliance using a USB disk, enter the **Settings** menu and select **USB disk**. Further details are available in chapter **6/6.1.2**.

The VisionCombi software is available at the manufacturer's website.

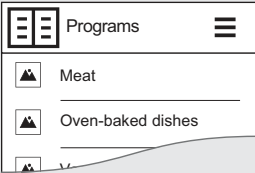
4.2.5 Create a new program category

<p>1 ENTER THE PROGRAMS Press</p>	 Programs
<p>2 PRESS</p>	
<p>3 SELECT</p>	<div style="border: 1px solid black; padding: 5px; width: fit-content; margin: auto;">New category</div>
<p>4 ENTER THE NAME OF THE CATEGORY</p>	
<p>5 PRESS Now the new category is created and saved.</p>	<div style="border: 1px solid black; padding: 10px; width: fit-content; margin: auto;">Ok</div>

4.2.6 Editing a program category

<p>1 ENTER THE PROGRAMS Press</p>	 Programs
<p>2 SELECT THE CATEGORY YOU WISH TO EDIT AND HOLD IT DOWN FOR LONGER THAN 2 SECONDS.</p>	
<p>3 FROM THE MENU, SELECT THE MODIFICATION THAT YOU WISH TO MAKE.</p>	<div style="border: 1px solid black; padding: 5px; width: fit-content; margin: auto;"> Edit category Delete category Select Add to main screen </div>
<p>3.1 EDIT A CATEGORY  Enables editing of the category.</p>	
<p>3.2 OPTION: DELETE A CATEGORY  After confirming, you permanently delete the category.</p>	
<p>3.3 OPTION: SELECT  Select the current category or multiple categories by ticking fields and subsequently copy or move them to a different category of programs or delete them.</p>	
<p>After selecting a category, press and select one of the offered options.</p>	

3.4 OPTION: MOVE UP/DOWN
 Move any category to a different location in the category list.



Return to the category list and press



Select

Move up/down

Press and hold down any category and drag your finger to move it to a new location.

Press

Save

4.2.7 Last ten

In the menu Last ten, the last ten used cooking/baking methods are stored chronologically.

1 GO TO THE LAST TEN MENU



2 SELECT A PROGRAM

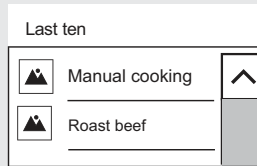

3 PROGRAM PREVIEW APPEARS (QUICKVIEW)

All program steps are displayed on a single screen with the option to edit or add further steps.



3.1 OPTION: EDIT PROGRAM



From the selected program, you can edit parameters or steps according to 4.2.2/7.1 to 7.4

4 START THE COOKING PROCESS BY PRESSING









5 AT THE END OF THE COOKING PROCESS, SELECT AN ACTION WITH WHICH TO CONTINUE (screen D)

4.2.8 Automatic program start

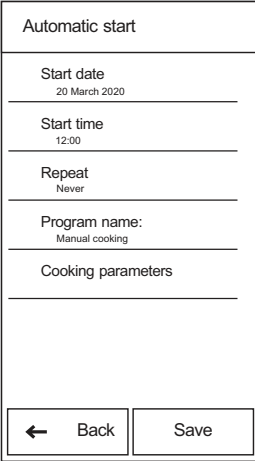
It is possible to set each program to start automatically and under the conditions that you set. This setting can be performed in any mode in which screen B, C or D is displayed and also on the cooking progress screen.

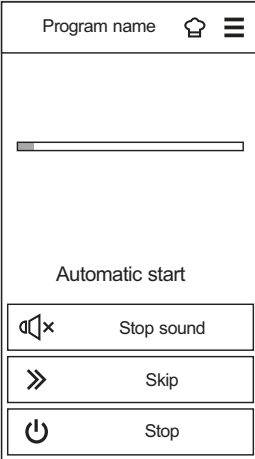
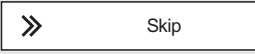
4.2.8.1 Setting a program for automatic start-up

<p>1 AT THE TOP OF THE SCREEN, PRESS Applies to screens B, C, D and the cooking progress screen</p>	
<p>2 PRESS</p>	
<p>3 SELECT AND SET THE AUTOMATIC START OPTIONS AS NEEDED</p>	
<p>4 PRESS</p>	
<p>A set automatic start program is indicated by a symbol on the upper ribbon of main screen A.</p>	
<p>Before automatic program start-up, the set date and time appear on the screen with the countdown and a sound is made</p>	
<p>You can skip the countdown by pressing</p>	
<p>You can also cancel the automatic start by pressing</p>	

4.2.8.2 Viewing, editing or deleting an automatically started program

1 ON THE MAIN SCREEN, PRESS
The list of programs set for automatic start-up is displayed.



1.1 OPTION: VIEW AUTOMATIC START ITEMS
Tap the desired program

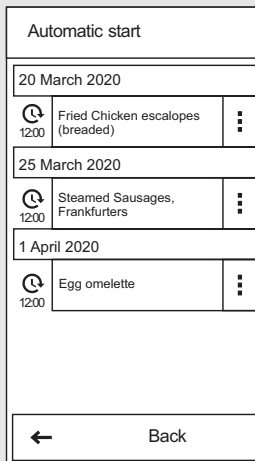

After viewing, press

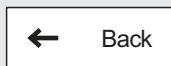

1.2 OPTION: EDIT AUTOMATIC START ITEMS

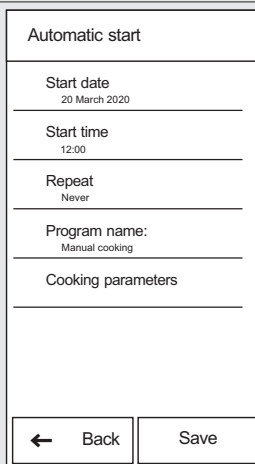



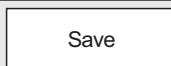

After making changes, press



4.3 MULTITASKING

The Orange Vision Plus enables you to work on multiple levels at once, without having to interrupt a cooking process that is running. For example, you may be cooking and at the same time, use Multitasking to switch to the programs section and prepare a new program. Multitasking does not enable performing such operations that would affect or interrupt the actual cooking process, e.g. start automatic cleaning.

4.3.1 Using the Multitasking function

<p>1 START COOKING IN ANY WAY, FOR EXAMPLE USING THE PROGRAMS  4/4.2.1</p>	
<p>2 PRESS THE BUTTON</p>	
<p>3 PRESS THE BUTTON You will go to the main screen (A)</p>	
<p>4 AFTER SWITCHING, A CHEF'S HAT ICON WILL START FLASHING ON A YELLOW BACKGROUND The icon indicates that a cooking process is running.</p>	
<p>5 ON THE MAIN SCREEN (A), YOU MAY SELECT AN OPTION WITH WHICH YOU WISH TO WORK This selection must not affect the cooking process. You cannot select, for example, the Cleaning function</p>	
<p>6 RETURN TO THE COOKING PROCESS SCREEN BY PRESSING THE FLASHING CHEF'S HAT ICON.</p>	

05 | OTHER

The category Other offers special cooking programs for modern culinary methods, which allows you to use the appliance for unusual procedures.

5.1 LOW-TEMPERATURE BAKING

This mode is especially appropriate for slow, gentle roasting of various meats. It allows maximum nutritional values to be retained in meat. The meat loses a minimum of weight and is juicy inside.

5.1.1 Cooking in Low-Temperature baking mode

1 ENTER THE CATEGORY OTHER

Press



Select



2 PRESS

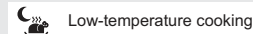

3 SELECT MEAT TYPE

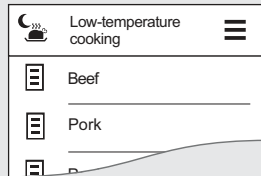

Shows a preview of all program steps (QuickView, screen C). Click on a selected program step, to can edit it parameters in the same way as when working with programs (screens B, C) as required.

Start the cooking process by pressing

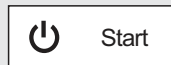

4 WHEN THE COOKING PROCESS HAS FINISHED END, SELECT THE ACTIVITY WITH WHICH YOU WISH TO CONTINUE (screen D)

5.2 REGENERATION AND KEEP WARM

This program is used for regenerating cooled foods. Keep warm then keeps the food at the set temperature for the necessary length of time. Food can be regenerated and kept warm either in gastronorm containers and/or directly on plates.

1 PRESS



2 SELECT REGENERATION AND KEEP WARM

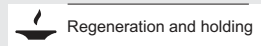

3 SELECT MODE

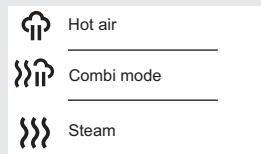

Shows a preview of all program steps (QuickView, screen C). Clicking on the selected program step, you can change parameters exactly as when working with programs (screens B, C), as needed.

4 START THE COOKING PROCESS BY PRESSING

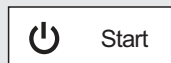

5 AT THE END OF THE COOKING PROCESS, SELECT AN ACTION WITH WHICH TO CONTINUE (SCREEN D)

06 | SETTINGS

6.1 BASIC SETTINGS

1. USER SETTINGS



When pressed, the numerical keypad will appear. To enter the settings, it is necessary to enter password **1001** and confirm using OK.

Date and time

Set or adjust the time. Only an authorised service has the authorisation to adjust the date.

Language (Language)

For setting the language of the system.

Temperature units

Allows setting the temperature units to °C or °F.

Sounds

Set the melody, volume and sound duration for the following items:

- Errors
- Keyboard
- Ending the cooking process
- Audible step signal
- Preheating
- Planned events
- End of cleaning
- Core probe

Display

Enables the setting of:

- Screen brightness - set using a slider. The default setting is 100%.
- Screensaver - Select the screensaver and the time after which the appliance will switch to the screensaver mode when idle. A further option is to show the time and a slide show (screen saver made up of images).
- Colour schemes - cannot be changed

Cooking

Enables various preferences to be set for comfortable operation of the appliance:

- **ACM** (Automatic capacity management) - this function will ensure that the appliance will identify the amount of food that is inserted and will extend the cooking time accordingly to achieve the required temperature in the cooking chamber. The default setting is "On" .
- **Preheating**
 - Preheat always active (for Manual mode settings)
 - The default setting is "On" .

- Increasing the temperature allows setting how many degrees higher than the set temperature the cooking chamber should preheat to. The default setting is 15°C. Example: When a temperature of 150° is set, the appliance automatically heats to a temperature of 165 °C, ATTENTION: Applies only to Hot air and Combined mode. In Steaming mode, the preheat temperature equals the set temperature.
- Maximum preheating time — For setting the maximum time after which the cooking process starts and begins to count down the time. The default value is 5 minutes.

• Cooking modes bar

Allows you to set which cooking modes will be available on the cooking modes bar, in Manual mode or during program creation. Pressing the symbol  allows more modes to be added.

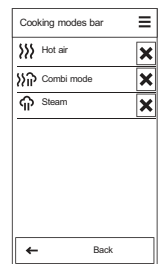

• Default values

Allows editing the basic parameters, such as humidity, core probe temperature, chamber temperature, fan speed and the following functions

- Hot air
- Combined mode
- Steam

• Standby after cooking

Enable
 The default setting is off
 Standby delay
 The default setting is 1 min

• Time units

For selecting the time format: h:m or h:m:s

• Extra time

Allows setting whether the prompt "Continue cooking" is shown on the screen after cooking is over.
 The default setting is "On" .

• Learn function

Allows setting whether the prompt "Save as a program" is shown on the screen after cooking is finished.
 The default setting is "On" .

• Eco Logic

Allows setting whether the prompt "Eco Logic" is shown on the screen after cooking is over.
 The default setting is "On" .

Cleaning

• Cleaning programs

Function is only available for service technicians

• Standby after cleaning

Allows the appliance to turn off after cleaning is done. The appliance's shut-off time can be set in minutes.

The default is "Allow"

Standby delay: the default value is "1 min"

Locks

Allows programs to be locked against editing.

After locking, the program can be launched, but it can't be edited or deleted.

• Program sets

Default setting is "Programs locked"

Setting the "Programs locked" option allows changes to be made to a saved program, except for making changes for one specifically started program using QuickView.

• Appliance lock

This function is not accessible for ordinary users — only for service technicians.

• Running program lock

The default setting is "Allow"

After allowing it, it will not be possible to make any changes to the saved program, not even for a single start. In the QuickView program steps view, it will not be possible to edit the steps.

2. INFO

When pressed, the appliance and control system details will be shown.

3. SERVICE

This option is permitted only to service technicians or experts and is protected by a password.

4. OPERATION LOGS

Errors

This function is not accessible for ordinary users — only for service technicians.

Operating events record

Shows a complete report of all operating events. Enables data to be filtered according to own parameters or for the last week, month and year.

HACCP record

For displaying a complete report of HACCP data right on the display.

Operating statistics

Function is only available for service technicians

5. USB DRIVE

Back up various items of the control system to an external USB drive or conversely import items from an external disk to the appliance.

• From the appliance to a USB disk

- Programs – A detailed description of saving programs is given in the separate chapter 6.1.1.
- Errors - the filename has the format "ErrorReport_Blue Vision_0-rrrr_mm_dd.txt"
- HACCP- the filename has the format "HaccpReport_Blue Vision_0-rrrr_mm_dd.haccp"
- Operating events report - the filename has the format "Log_Blue Vision_0-rrrr_mm_dd.txt"
- Settings - the filename has the format "Oven_Blue Vision_0.zip"
- More – This menu is not accessible to ordinary users — only for service technicians with a special password.

When one of the options is selected, the message **Connect a USB drive** will appear and the system will wait for its connection (Fig 1.2, point 6) .

After connection, the message **USB disk connected** and the prompt **Copy data to USB drive** will appear. Tap the menu to transfer the data to the USB drive.

• From USB to the appliance

- Programs – A detailed description of program copying is given in the separate chapter 7.1.1.
- Melody - Only files in the "*.wav" format
- More – This menu is not accessible to ordinary users — only for service technicians with a special password.















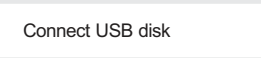

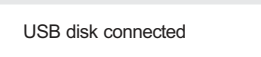
When one of the options is selected, the message **Connect a USB drive** will appear (Fig 1.2, point 6) and the system will wait for its connection.

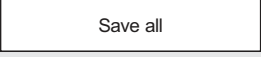
After connection, the contents of the USB drive will be shown, which can be browsed through in the same way as on a regular PC. You can select and copy individual files or even whole folders. Tapping on the selected file or folder will copy it to the appliance.

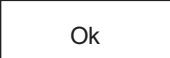
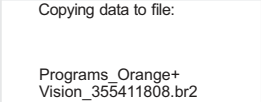
 **Program files (*.br2), HACCP (*.haccp) may only be administered using VisionCombi software, which is available at the manufacturer's website.**

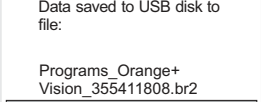
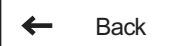
6.1.1 Saving programs to the USB drive

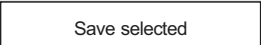
If you wish to save programs of the appliance to an external USB drive, proceed as follows:

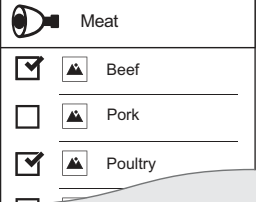
<p>1 PRESS</p>	
<p>2 PRESS</p>	
<p>3 PRESS</p>	
<p>4 SELECT THE PROGRAMS</p>	
<p>5 A MESSAGE APPEARS Connect a USB drive (📄 1.2, point 6)</p>	
<p>6 A MESSAGE APPEARS  If the USB drive is damaged or incompatible, "USB drive was not recognized" will appear. Use a different USB drive.</p>	
<p>6.1 OPTION: SAVE ALL  For saving all programs from the memory of the appliance to one file on the USB drive.</p>	
<p>Press</p>	
<p>The default output file is displayed. You can overwrite the filename as required.</p>	
<p>Enter your own filename or leave the preset filename and press</p>	
<p>Saving progress is shown</p>	
<p> An information message appears when file is successfully saved. If the file is not successfully saved, the message "Data saving error" will appear. Repeat the file saving procedure or use a different USB drive.</p>	
<p>Disconnect the USB drive and press</p>	
<p>6.2 OPTION: SAVE SELECTED  Allows selecting and saving selected programs or folders</p>	
<p>Press</p>	
<p>All programs with tick boxes are displayed</p>	
<p>6.2.1 OPTION: SAVE COMPLETE FOLDERS Tapping on any tick box to select a complete folder, including the program inside</p>	

6.2.2 OPTION: SAVE SPECIFIC PROGRAMS
Tapping on the folder name shows a menu of all programs, along with tick boxes.

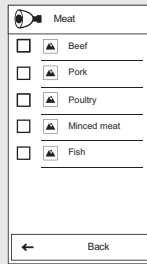

Tap on any tick box to select the desired programs.

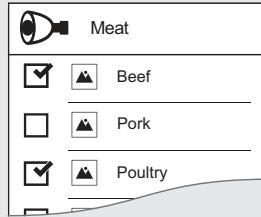

After selecting folders or programs, press

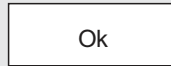

The default output file is displayed. You can overwrite the filename as required.



Confirm the preset or your own entered file name by pressing



Saving progress is shown

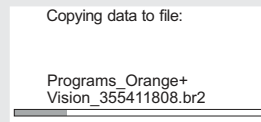

 An information message appears when saving is successful. If the file is not successfully exported, the message "Data saving error" will appear. Repeat the file saving procedure or use a different USB drive.

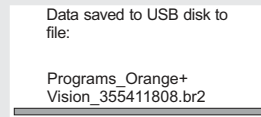









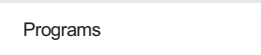
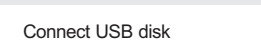

Disconnect the USB drive and press

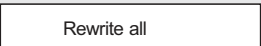

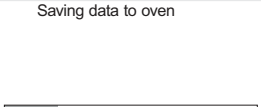
6.1.2 Copying files from a USB drive to the appliance

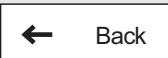
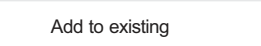
If you wish to copy programs from an external USB drive to the memory of the appliance, proceed as follows:

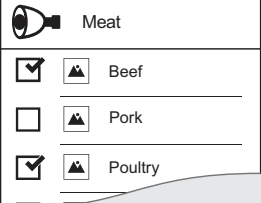
<p>1 PRESS</p>	
<p>2 PRESS</p>	
<p>3 PRESS</p>	
<p>4 SELECT</p>	
<p>5 A MESSAGE APPEARS Connect a USB drive (see 1.2, point 6)</p>	
<p>6 CONTENTS OF USB DRIVE WILL BE SHOWN</p> <p> Only files with the "br2" extension are shown. This format must only be administered using VisionCombi software, which is available at the manufacturer's website.</p>	
<p>6.1 OPTION: OVERWRITE ALL For replacing all programs in the memory of the appliance with programs on the USB drive</p>	
<p>Press</p>	
<p> CAUTION – All original programs in the memory of the appliance will be irrecoverably overwritten with programs from your USB drive</p>	
<p>Saving progress is shown</p>	
<p>An information message appears when saving is successful.</p>	
<p>Disconnect the USB drive and press</p>	
<p>6.2 OPTION: ADD TO PROGRAMS For adding new programs from a USB drive to the memory of the appliance</p>	
<p>Press</p>	
<p>A menu of folders with programs, along with tick boxes</p>	
<p>6.2.1 OPTION: ADD COMPLETE FOLDERS Tapping on any tick box to select a complete folder, including the program inside</p>	

6.2.2 OPTION: ADD SPECIFIC PROGRAMS
 Tapping on the folder name shows a menu of all programs, along with tick boxes.

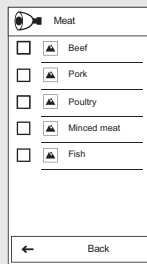

Tap on any tick box to select the desired programs.

i If you want to select programs from other folders, go back to a higher level using the "Back" button and select a different folder. Programs already ticked will remain ticked.

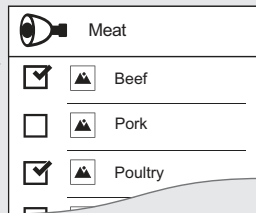

After selecting folders or programs, press

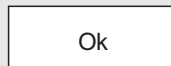

Saving progress is shown

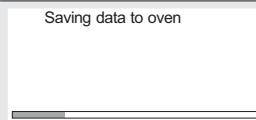

An information message appears when saving is successful.

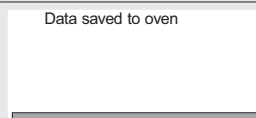

Disconnect the USB drive and press

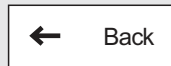

6.2 DATA HACCP

The HACCP system (Hazard Analysis and Critical Control Points) automatically records everything that happens inside your appliance. The saved data can be subsequently shown directly on the display or downloaded on to a computer.

6.2.1 Viewing HACCP data

1 PRESS



2 SELECT THE DATE

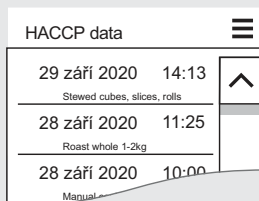

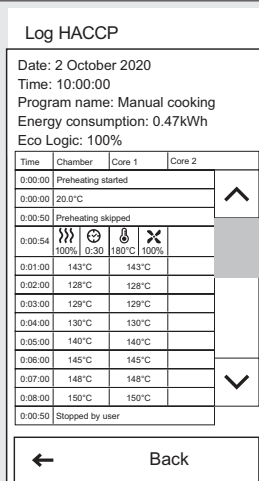

3 VIEW THE DATA



4 TO RETURN, PRESS



6.2.2 Copying HACCP data to the USB drive

1	PRESS	
2	PRESS	USB disk
3	SELECT	Oven to USB
4	SELECT	HACCP
5	A MESSAGE APPEARS Connect a USB drive (see 1.2, point 6)	Connect USB disk
6	A MESSAGE APPEARS If the USB drive is damaged or incompatible, "USB drive was not recognized" will appear. Use a different USB drive.	USB disk connected
7	PRESS	Download data to USB disk
	Saving progress is shown	Copying data to file: HaccpReport_Orange+_Vision_355411808-2020-10-10.haccp
	An information message appears when file is successfully saved. If the file is not successfully saved, the message "Data saving error" will appear. Repeat the file saving procedure or use a different USB drive.	Data saved to USB disk to file: HaccpReport_Orange+_Vision_355411808-2020-10-10.haccp Now you can disconnect USB disk
8	PRESS	 Back

07 | MAINTENANCE

GENERAL INSTRUCTIONS

For the entire period of operation, the appliance must undergo regular inspections, tests and updates for operating this type of appliance in accordance with applicable regulations in the country of use.

The appliance must be kept clean, and any remains of old fat and food must be removed. Only regular maintenance and adherence to all instructions can ensure that the appliance will last a long time, operate well, and prepare high-quality foods.

Once work is over, close the appliance's water supply! Only keep it connected in the case that there is a water treatment device connected that requires regular regeneration. The warranty does not apply to damage caused by failure to follow these instructions or caused by inadequate cleaning!

Damages resulting from non-adherence to these instructions and caused by inadequate cleaning are not covered by the warranty!

The following must not be used for cleaning the appliance:

- high pressure cleaner
- abrasive sand-based cleaning agents or coarse-grain cleaning agents
- mechanical surface cleaning tools (wire brushes, scrapers, knives)

The warranty does not cover damages arising as a result of using cleaning agents other than those recommended by the manufacturer, or as a result of using the cleaning agents recommended by the manufacturer in contradiction to the recommendations of the manufacturer!

If the appliance is defective or does not behave normally, stop using it, unplug it, and contact an authorised service company.



Before using or maintaining the appliance, become thoroughly familiar with all instructions, prohibitions and recommendations in the chapter SAFETY DURING USE.

Do not spray water from the shower on the door's glass and lights, if the internal temperature is above 65 °C. This risks cracking the glass and injury to the operator!

MAINTENANCE OVERVIEW		
INTERVAL	DESCRIPTION	DESCRIPTION OF TASK
Daily	Cooking chamber	Cleaning with the automatic program and Active Cleaner
	Door seal	Manual cleaning using a cloth, detergent and water
	Exterior parts	Manual cleaning using a soft rag and substance for treating stainless steel and glass
Weekly	Cooking chamber	Cleaning with the automatic program and Vision Descaler
	Space behind the inner wall	Hand cleaning using Manual Cleaner or Puron K and the following RINSE program
	Air filter	Manual cleaning with detergent or in a dishwasher
	Cleaning the door and glass	Hand cleaning using cloths and appropriate cleaning agents
Every six months*	Boiler	Descaling using the automatic program and the Strip-A-Way agent
Yearly	Entire appliance	Inspection by an authorised company

* applies only to appliances with a boiler

7.1 DAILY MAINTENANCE

The appliance must be cleaned daily with the manufacturer's recommended cleaning agents. If not cleaned adequately, the appliance or its parts may become damaged.

CLEANING THE COOKING CHAMBER

For everyday appliance cleaning, use one of the programs in the Cleaning function, which you will find in the appliance's menu.

The manual for using automatic cleaning can be found in chapter **9. Automatic cleaning.**



When cleaning, use only cleaning agents recommended by the manufacturer — especially Active Cleaner and Vision Descaler.

After the cleaning program has finished, check whether the cleaning was adequate. If not, repeat the cleaning process. If residue of a cleaning agent sticks to the surface of the cooking chamber or its accessories, rinse it with the hand shower or start the Rinse with water program. If this isn't done, the stainless-steel surface of the cooking chamber can distort and discolour when the appliance is used at high temperatures. The warranty does not cover damage caused in this way!

After the cooking chamber has been cleaned, open the door and leave it half open to fully dry out the chamber.



CLEANING THE EXTERNAL PARTS

Clean the outside of the appliance with a soft cloth and a detergent intended for cleaning and treating stainless steel and glass.



When working with detergents always take great care to follow the manual and recommendations of the detergent manufacturer. This will prevent hazards to your health!

When cleaning the appliance, always use safety gear and prescribed work clothing (gloves, goggles, mask)!

When using automatic cleaning programs on appliances with a loading trolley, it is absolutely necessary to move the trolley into the appliance before starting the cleaning program!

Automatic cleaning programs are not for cleaning gastronorm containers or sheets!

While the appliance is cleaned with a detergent, its temperature must under no circumstances exceed 70 °C. At higher temperatures, the detergent may bake on to the surface of the cooking chamber and form stains resembling rust or cause other damage to the appliance. The warranty does not apply to this type of damage!

CLEANING THE DOOR GASKET SEAL

After the cooking chamber has been cleaned, wipe around the door gasket seal with a soft cloth soaked in detergent. Then wipe around the gasket seal with a cloth soaked in clean water, and then dry it with a dry cloth. After cleaning is over, leave the appliance's door half open, so that the cooking chamber and door gasket seal can properly dry off.

7.2 WEEKLY MAINTENANCE

DESCALING THE COOKING CHAMBER

If a crust of limescale appears on the surface areas of the cooking chamber, descale the cooking chamber using the "Cooking chamber descaling" program, and use the Vision Descaler product for this.



If the cooking chamber becomes considerably scaled, find out the current composition of the water, the correct operation of the water treatment device, if there is such an appliance on the front end. Damage caused by water that does not meet the manufacturer's requirements, or inadequate maintenance, is not covered by the warranty!

INSPECTING AND CLEANING THE SPACE BEHIND THE INNER WALL

For weekly maintenance, proceed as with daily maintenance (see chapter 7.1) and thoroughly check the space behind the inner wall.

1. Clean out the left and right racks (does not apply to appliances with a loading system).

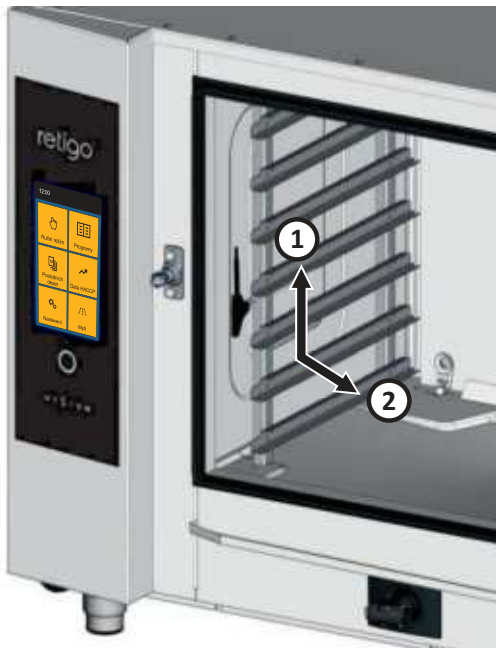

2. Release the locks fastening the wall in front of the fan. A screwdriver or coin can be used to release them.

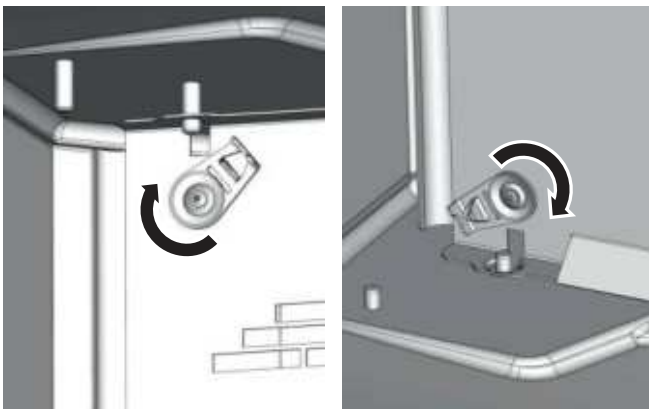

Open the inner wall by pulling on the left side.



If parts of the space are soiled or calcified, close the inner wall, secure it with the lock, and choose the right cleaning program for the type and level of soiling. After the cleaning program has finished, check whether the cleaning was adequate (proceed according to points 2 to 3). If everything is not clean enough, repeat the process. If cleaning was adequate, close the inner wall (in front of the fan), use the integrated lock to secure it against opening by itself, and put both racks back (does not apply to appliances with a loading system).

3. After cleaning is over, leave the appliance's door open so that the cooking chamber can fully dry out. This also makes the door seals last longer.

HAND CLEANING OF THE SPACE BEHIND THE INNER WALL



In rare cases, even repeated automatic cleaning and descaling may be ineffective against tough grime behind the inner wall. In such cases, a cleaning agent (Manual Cleaner) or descaler (Puron K) must be applied by hand as follows:

1. Open the inner wall in the manner described earlier in this chapter.
2. Spray Manual Cleaner or Puron K (for descaling) on to the entire surface of the inside wall – fan, water sprayer (tube in the middle of the fan into which the injection leads) and the heating element – and let it work for 15 minutes.
3. Thoroughly rinse the cooking chamber by starting the automatic cleaning program - Rinse with water.
4. After the cleaning program has finished, check whether the cleaning was adequate. If everything is not clean enough, repeat the process. If cleaning was adequate, close the inner wall (in front of the fan), use the integrated lock to secure it against opening by itself, and put both racks back (does not apply to appliances with a loading system).
5. After cleaning is over, leave the appliance's door open so that the cooking chamber can fully dry out. This also makes the door seals last longer.

CLEANING THE AIR FILTER

Once a month, check and clean the air filter, which is on the bottom left side of the appliance.

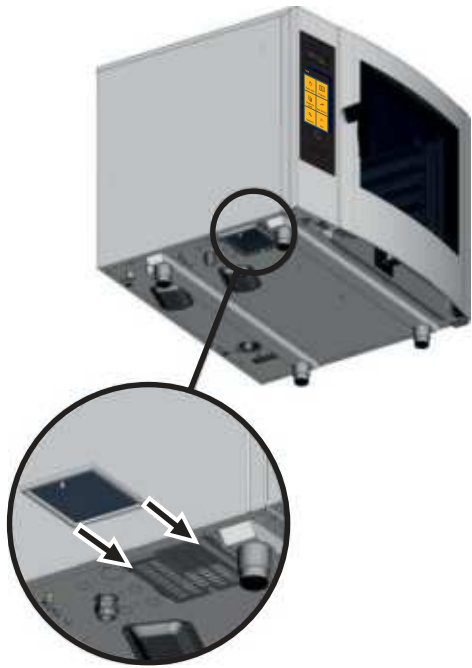

Remove the filter toward the closer side of the appliance and thoroughly clean it with detergent or in a dishwasher. After cleaning, allow it to dry out well.



In the event that the air filter becomes clogged, the electronic components of the appliance may overheat and the working order of the appliance may be limited.

CLEANING THE DOOR, GLASS AND DRIP TRAY

1. Open the appliance door.
2. Check the drip tray at the bottom of the door. If it is dirty, clean it with a soft cloth and detergent.
3. Check the drip tray at the bottom of the appliance. If it is dirty, clean it with a soft cloth and detergent.



Unlock the internal glass and tilt the glass up.

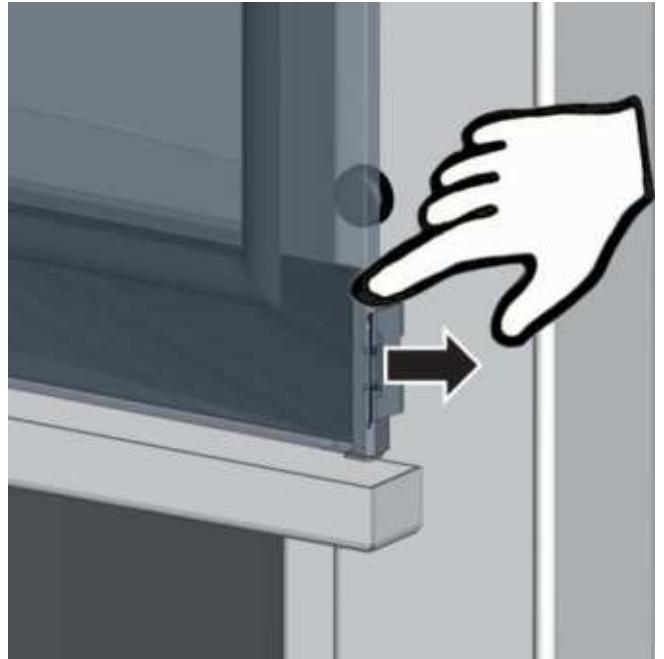

5. Clean all glass surfaces with a clean rag and detergent intended for glass.
6. Then dry the glass surfaces with a dry cloth.
7. Wipe the seal of the middle glass with a damp cloth and then dry it.



8. Gradually return the middle and inner glass to their original position and secure them with the lock by gently pressing the inner glass near the lock.

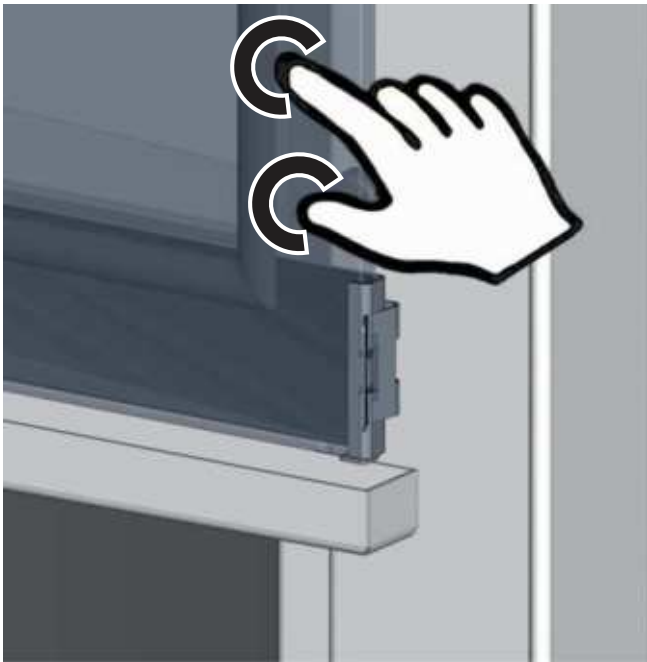

7.3 HALF-YEARLY MAINTENANCE

DESCALING THE BOILER

Even though appliances with a boiler are equipped with an automatic function that ensures regular exchange of water in the boiler and cleans the boiler of ordinary deposits and dirt, it must be thoroughly descaled once every 6 months. This prevents damage to the heating elements and ensures that the boiler works properly. The warranty does not cover damage due to a scaled boiler!

Depending on the water quality, the appliance's boiler may need descaling more often. If the boiler is heavily scaled, the appliance may not work properly.



Only an authorised service company is to descale the boiler.

7.4 YEARLY MAINTENANCE

For safe, trouble-free operation, the appliance and its accessories must be inspected by an authorised service company at least once per year.

08 | AUTOMATIC CLEANING

The Orange Vision Plus is equipped with an automatic cleaning system, which ensures that your appliance will always be perfectly hygienically clean.

Regular use of this automatic cleaning system saves you time and significantly prolongs the lifespan of the appliance.

Thanks to this system, the only cleaning tasks on this appliance are:

- choosing the right cleaning program for the level of soiling
- starting the cleaning program and adding detergent

8.1 AUTOMATIC CLEANING: WHAT YOU SHOULD KNOW



For automatic cleaning, you must use the Active Cleaner detergent, which is packed in 60 g plastic bags. It is delivered in small buckets containing 50 packs.

The detergent's package protects it from moisture damage, but it should nonetheless be stored in places where no water or excess humidity is present. Always use the detergent immediately after opening the package. Never leave it open, and most importantly, do not leave it in damp places or unsupervised.



Important:

- If a detergent other than the original Active Cleaner is used (or Manual Cleaner, Vision Descaler), Retigo takes no responsibility for any damage, and the warranty does not apply to damage caused in this way.
- Keep the detergent out of the reach of children.
- When handling the detergent, follow all rules for working safely with chemical substances, and especially use safety gear (mainly gloves and protective glasses).
- Follow the instructions on the detergent package.
- The detergent must never come into direct contact with the skin, eyes or mouth.
- Never open the appliance's door when the cleaning program is running – this can cause a chemical exposure hazard.
- Before cleaning, remove all gastronomic containers from the appliance.
- Follow all instructions shown on the appliance's display.
- After using the detergent, do not leave the detergent package in the cooking chamber.
- Never spill the detergent on the appliance's hot surface – this can irreversibly damage the stainless steel surface. The warranty does not apply to appliances damaged in this way.
- If cleaning is inadequate, fat build-up in the appliance's cooking chamber may ignite during ordinary operation.

The appliance has six cleaning programs. The program that is to be used depends on the level of soiling in the cooking chamber – see the table below.

PROGRAM	DESCRIPTION	DURATION *
	Water rinse - rinse of the cooking chamber with lukewarm water without detergent.	14:53
	Express cleaning - Short cleaning of light soiling.	33:39
	Basic cleaning - Cleaning of light soiling.	50:19
	Medium cleaning - Cleaning of medium level soiling.	01:15:19
	Extra strong cleaning - Cleaning of very heavy soiling.	01:48:39
	Descaling of the cooking chamber - Removing limescale deposits.	01:12:44

* The cleaning times indicated apply to size 611. This data may differ slightly for appliances of a different size.





















Depending on the size of the appliance and the cleaning program chosen, it is also necessary to select the right amount of detergent. The amount of cleaning agent needed depends on the degree and character of the appliance's soiling.

PROGRAM		SIZE OF APPLIANCE					
		AMOUNT OF DETERGENT (pcs)					
		623	611	1011	1221	2011	2021
	Water rinse*	0	0	0	0	0	0
	Express cleaning	1	1	1	2	2	3
	Basic cleaning	1	1	1	2	2	4
	Medium cleaning	1	1	1	2	2	4
	Extra strong cleaning	1	2	2	3	3	5
	Cooking chamber descaling**	1	1	1	2	2	3

* Water rinse is performed without detergent.

** Use Vision Descaler for descaling.

8.2 STARTING THE CLEANING PROCESS

<p>1 ENTER THE CLEANING MODE</p>	 Cleaning												
<p>2 SELECT THE APPROPRIATE MODE</p>	<table border="1"> <tr> <td></td> <td>Water rinsing 0:14:53</td> </tr> <tr> <td></td> <td>Express cleaning 0:33:39</td> </tr> <tr> <td></td> <td>Basic cleaning 0:50:19</td> </tr> <tr> <td></td> <td>Medium cleaning 1:15:19</td> </tr> <tr> <td></td> <td>Extra strong cleaning 1:48:39</td> </tr> <tr> <td></td> <td>Cooking chamber descaling 1:12:44</td> </tr> </table>		Water rinsing 0:14:53		Express cleaning 0:33:39		Basic cleaning 0:50:19		Medium cleaning 1:15:19		Extra strong cleaning 1:48:39		Cooking chamber descaling 1:12:44
	Water rinsing 0:14:53												
	Express cleaning 0:33:39												
	Basic cleaning 0:50:19												
	Medium cleaning 1:15:19												
	Extra strong cleaning 1:48:39												
	Cooking chamber descaling 1:12:44												
<p>3 TO START THE CLEANING PROGRAM, PRESS Wait for the detergent insert prompt.</p>	 Start												
<p>TO RETURN TO THE CLEANING MODE LIST, PRESS</p>	 Back												

When Start is pressed, the appliance automatically checks that the temperature inside the cooking chamber is not too high. If the temperature is above 80 °C, the automatic process for cooling the cooking chamber will begin. If the temperature does not exceed 80°C or cooking chamber cooling has finished, your appliance will prompt you to add detergent.

 **When handling the cleaning agent, follow all rules for working with chemical substances!**

ADDING DETERGENT



- Cut open the detergent bag at the place indicated
- Pour the entire contents of the package on to the drain lid at the bottom of the cooking chamber. Most of the powder will fall through into the drain hole.
- close the door of the appliance

The selected program will start automatically, and the screen will keep you informed about the current status of the program and the cleaning time left.

After the cleaning program ends, a signal sound is made and a message appears. Now, the appliance is ready to be used again.

STOPPING THE CLEANING PROGRAM PREMATURELY

You can interrupt the cleaning process during the main step with the **STOP** button shown on the screen. If you do this, the appliance will ask if you really want to stop it. If you confirm, the program will switch to rinse mode, which lasts about 16 minutes. Then the cleaning process is completely finished. If you do not confirm the pause and press **No**, the process will continue where it left off.



- When the cleaning process has finished, check the cooking chamber. Remove any remaining detergent by thoroughly rinsing with the hand shower or cleaning with water. If this isn't done, the stainless-steel surface of the cooking chamber can distort and discolour when the appliance is used at high temperatures. The warranty does not cover damage caused in this way!
- Do not clean the appliance using equipment that works with high water pressure.
- If the appliance will not be used again after cleaning, we recommend leaving the door ajar, e.g. overnight.
- Dispose of the detergent package as usual, by putting it in a place reserved for plastic bags.
- Never leave used packages lying around freely accessible.

DESCALING THE COOKING CHAMBER

Descaling is recommended when there are visible lime scale deposits in the cooking chamber (a white layer of water scale). To descale the appliance, the special Vision Descaler agent must be used.

This agent is applied in the same way as Active Cleaner. The standard package for Vision Descaler is a plastic bucket containing 25 bags of 150 g.

09 | ERROR MESSAGE TABLE

When working with the appliance, the display may show error messages. Their meanings are as follows:

ERROR	DESCRIPTION	SOLUTION
Err 10	The minimum water level was not reached in the boiler within the set time limit despite the maximum water level being reached.	The combi oven will automatically switch to the reserve injection state and it is possible to continue using it temporarily. After the combi oven is turned off and then on again, it will try to start up the boiler. If the problem reoccurs, please contact an authorised service company.
Err 11	Chamber heating element error.	The combi oven cannot continue operating. Contact an authorised service company.
Err 12	The maximum water level was not reached in the boiler within the set time limit.	The combi oven will automatically switch to the reserve injection state and it is possible to continue using it temporarily. After the combi oven is turned off and then on again, it will try to start up the boiler. If the problem reoccurs, please contact an authorised service company.
Err 13	The minimum water level was not reached in the boiler within the set time limit.	Check the water supply inlet (open tap). The combi oven can be used temporarily only in hot air mode. If the problem reoccurs, even when water supply is provided, please contact an authorised service company.
Err 15	Failure of motor heat protection. Signals motor overheating above the set limit.	Contact an authorised service company.
Err 16	The boiler was not preheated within the set time limit.	The combi oven will automatically switch to the reserve injection state and it is possible to continue using it temporarily. After the combi oven is turned off and then on again, it will try to start up the boiler. If the problem reoccurs, please contact an authorised service company.
Err 17	When draining the boiler, the water level did not fall below the minimum water level within the set time limit.	
Err 18	When draining the boiler, the water level did not fall below the maximum water level within the set time limit.	The combi oven will automatically switch to the reserve injection state and it is possible to continue using it temporarily. After the combi oven is turned off and then on again, it will try to start up the boiler. If the problem reoccurs, please contact an authorised service company.
Err 26	Flap valve error. The automatic flap valve is not working correctly.	Incorrect function of the flap valve may affect cooking results, however, it is possible to continue using the combi oven temporarily. Contact an authorised service company.
Err 31	Drain heat sensor error.	The combi oven can temporarily be used in all modes. Contact an authorised service company.
Err 32	Boiler heat sensor error.	The combi oven will automatically switch to the reserve injection state and it is possible to continue using it temporarily. After the combi oven is turned off and then on again, it will try to start up the boiler. If the problem reoccurs, please contact an authorised service company.
Err 34	Error of the 1-point temperature probe.	The combi oven can temporarily be used in all modes with the exception of the modes with a temperature probe. Contact an authorised service company.
Err 35	Chamber heat sensor error.	Error blocks work in all modes. Contact an authorised service company.
Err 37	Thermistor disconnected.	Contact an authorised service company.
Err 38	Thermistor short-circuited.	Contact an authorised service company.

Err 40	Outage of the chamber thermal fuse, boiler (boiler combi ovens only), draught interrupter (only gas combi ovens with a draught interrupter) or switchboard thermal fuse.	Contact an authorised service company.
Err 41	Cooling error - overheating of electronics.	Clean the dust filter. If the error occurs repeatedly, please contact an authorised service company.
Err 42	Overheating of the boiler heating element.	The combi oven will automatically switch to the reserve injection state and it is possible to continue using it. After the combi oven is turned off and then on again, it will try to start up the boiler. If the problem reoccurs, please contact an authorised service company.
Err 60-79	Modbus communications error.	Disconnect the power supply to the combi oven (not "Standby" mode), wait 30 seconds and then turn on the combi oven again (reconnect the power supply). If the problem reoccurs, please contact an authorised service company.
Err 80-91	Frequency converter error.	If the problem reoccurs, please contact an authorised service company.
Err 95 Err 97	Incorrect blower speed.	
Err 96 Err 98	Lighting up error.	Check that the gas supply is open and try to start cooking again. If the problem reoccurs, please contact an authorised service company.
Err 100	System error	Contact an authorised service company.



- Equipment failures can be repaired by authorised service only, which is trained and certified by the manufacturer. Warranty does not apply in the case of improper or unauthorised service!
- For the entire observation time, the appliance must be subjected to regular inspections, tests and reviews according to the applicable regulations in the owner's country.

10 | SERVICE LIFE, TAKING OUT OF OPERATION AND WARRANTY

SERVICE LIFE

The product's service life is 10 years if the following conditions are adhered to: a regular preventative service inspection after every 12 months of operation, whilst this inspection must be performed by service technicians from a Retigo-authorized partner company.

The user must present a list of service events.

The user must precisely follow the instructions in the user's manual.

The user must maintain and clean the appliance daily using cleaning agents recommended by Retigo.

If the appliance has automatic cleaning, cleaning agents recommended by Retigo must be used exclusively.

Training of operators by a Retigo professional cook must be documented in the service booklet or by copies of the operator training log.

If operating personnel change, training must be conducted again.

TAKING OUT OF OPERATION – DISPOSAL

For disposal of the appliance after it has been taken out of operation, it is necessary to comply with applicable national regulations on waste disposal. The appliance contains electrical parts (electronics, transformer, halogen lamps, battery, etc.) that may damage the environment if disposed of improperly.



The appliance and its parts MUST NOT be disposed of in communal waste!

The appliance's end user must choose among three of the following disposal options:

Disposal by RETIGO s.r.o.

Order the disposal of the equipment by RETIGO by calling the telephone number +420 571 665 511 or by email at info@retigo.cz

How to prepare the appliance for disposal:

- Professionally disconnect the appliance from the utilities
- Place the appliance on a pallet, secure it with shrink-wrap, and transport it to an appropriate loading location.



Removal and disposal are free for the end user. In cooperation with a contracted company, Retigo s.r.o. will arrange the removal and disposal of the appliance in accordance with applicable law. Likewise, Retigo s.r.o. will arrange the disposal of other companies' appliances of similar type and use, if Retigo s.r.o. products are replacing them.

Disposal by the appliance's distributor

Order disposal of the appliance through the distributor, who will then arrange disposal with Retigo.

When ordering, provide the following information:

- exact address for picking up the appliance
- contact person, telephone
- pickup time for the appliance

Disposal on your own

If you decide to dispose of the appliance on your own, comply with applicable national waste disposal regulations. Take the appliance's sheet metal parts to an appropriate collection facility, and put the glass into recycling bins. Take ceramic insulation and electrical parts to a specialised company authorised to treat and dispose of such waste.

WARRANTY

The warranty period is noted in the service booklet and on the warranty certificate. Demand a confirmation of the warranty from the company that installed your appliance.

Not covered by the warranty are damage and failures caused by incorrect operation, failure to observe this user's manual, use of aggressive cleaning agents, and improper cleaning of the appliance. Also not covered are defects caused by installation that is not in keeping with the manufacturer's recommendations, incorrect repairs, unauthorised tampering and force majeure.

retigo[®]

PERFECTION IN COOKING AND MORE...

RETIGO s.r.o.

Láň 2310

756 61 Rožnov pod Radhoštěm

Email: info@retigo.cz

Tel.: +420 571 665 511

www.retigo.cz

ver.: TSD_15_EG_CZ_R00

model: Orange Vision Plus

version SW: 2.102